

AW-XM458MA-PUR

**IEEE 802.11 2x2 Wi-Fi 6 SU and MU-MIMO
CDW Wireless LAN + Bluetooth 5.1
Combo M.2 2230 Module**

Datasheet

Rev. D

DF

For Standard

Features

WLAN

- ◆ Support 2x2 802.11 a/b/g/n/ac/ax
- ◆ Dual bands: 2.4 GHz and 5 GHz
- ◆ Support 20/40/80 MHz channel Bandwidths.
- ◆ 5GHz PHY data rates up to 1.2 Gbps
- ◆ 2.4 GHz PHY data rates up to 458 Mbps
- ◆ Uplink and downlink OFDMA and MU-MIMO
- ◆ Instantaneous 0-DFS

WLAN Dual-Radios

- ◆ Dual, independent direct-conversion WLAN radios (with dual-MACs and dual-Basebands) supports true and simultaneous LAN network operation at two different frequency band

Bluetooth

- ◆ Bluetooth 5
- ◆ Bluetooth class 2
- ◆ Bluetooth class 1
- ◆ PCM interface for voice applications
- ◆ 2Mbit/s LE
- ◆ Long range
- ◆ LTE/MWS coexistence
- ◆ 2 x wide band speech (WBS) calls
- ◆ Security: AES

Revision History

Document NO: R2-2458MA-DST-01

Version	Revision Date	DCN NO.	Description	Initials	Approved
A	2020/07/21	DCN019506	<ul style="list-style-type: none"> ● Draft version 	Renton Tao	N.C Chen
B	2020/03/18	DCN021908	<ul style="list-style-type: none"> ● Correct pin definition table ● Modify table format 	Renton Tao	N.C Chen
C	2021/06/07	DCN022198	<ul style="list-style-type: none"> ● Update operating temperature ● Add the information of RF connector receptacle 	Roger Liu	N.C Chen
D	2021/08/13	DCN023047	<ul style="list-style-type: none"> ● Modify pin table ● Update power consumption ● Update RF specification ● Update BLE 1M spec 	Roger Liu	N.C Chen

Table of Contents

Revision History	3
Table of Contents	4
1. Introduction.....	5
1.1 Product Overview	5
1.2 Block Diagram.....	6
1.3 Specifications Table	7
1.3.1 General	7
1.3.2 WLAN.....	7
1.3.3 Bluetooth	9
1.3.4 Operating Conditions.....	10
2.1 Pin Table.....	11
3. Electrical Characteristics	13
3.1 Absolute Maximum Ratings	13
3.2 Recommended Operating Conditions	13
3.3 Digital IO Pin DC Characteristics	13
3.3.1 1.8V Operation (VIO).....	13
3.3.2 1.8V Operation (VIO_SD).....	14
3.4 Host Interface.....	15
3.4.1 PCI Express Interface	15
3.4.2.High-Speed UART Interface.....	17
3.5 Timing Sequence	18
3.6 Power Consumption*	19
3.6.1 WLAN.....	19
3.6.2 Bluetooth	20
4. Mechanical Information	21
4.1 Mechanical Drawing	21
5. Packing Information.....	22

1. Introduction

1.1 Product Overview

AzureWave Technologies, Inc. introduces the IEEE 802.11a/b/g/n/ac/ax Concurrent Dual Wi-Fi (CDW) and BT, combo module – **AW-XM458MA-PUR**. With High Efficiency Wireless (HEW) and backward compatible with 802.11ac technologies integrated into a module, AW-XM458MA-PUR provides the best and most convenient SMT process. The module is targeted to mobile devices including, Tablet PC, Portable Media Players (PMPs), Portable Navigation Devices (PNDs), Personal Digital Assistants (PDAs), Tracking Devices, Gaming Devices which need convenient SMT process, low power consumption.

By using AW-XM458MA-PUR, the customers can easily integrate the Wi-Fi, BT, by a combo module with the benefits of **high design flexibility, high success rate on SMT process, short development cycle, and quick time-to-market.**

Compliance with the IEEE 802.11a/b/g/n/ac/ax standard, the AW-XM458MA-PUR uses **DSSS, OFDM, DBPSK, DQPSK, CCK** and **QAM** baseband modulation technologies. A high level of integration and full implementation of the power management functions specified in the IEEE 802.11 standard minimize the system power requirements by using AW-XM458MA-PUR.

The AW-XM458MA-PUR supports standard interface **PCIe for WLAN** interface connection. High-Speed **UART for BT** interface connection. AW-XM458MA-PUR is suitable for multiple mobile processors for different applications. With the combo functions and the good performance, the AW-XM458MA-PUR is the best solution for the consumer electronics and the tablet PC.

Scenario	2.4GHz Band			5GHz Band		
	Mode	Technology	BW	Mode	Technology	BW
1	2x2	802.11n	40MHz	2x2	802.11ax	80MHz
2	2x2	802.11n	40MHz	1x1 1Rx	802.11ax Zero Wait DFS	80MHz 80MHz
3	2x2	802.11ax	40MHz	2x2	802.11ac	40MHz

Concurrent 2.4GHz and 5GHz modes supported table

1.2 Block Diagram

A simplified block diagram of the AW-XM458MA-PUR module is depicted in the figure below.

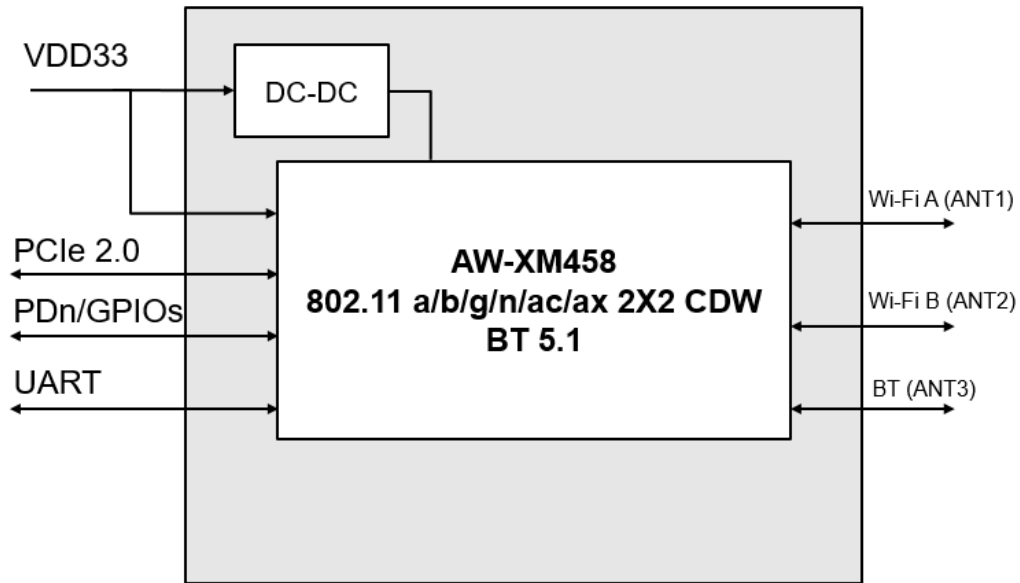

AW-XM458MA-PUR Block Diagram

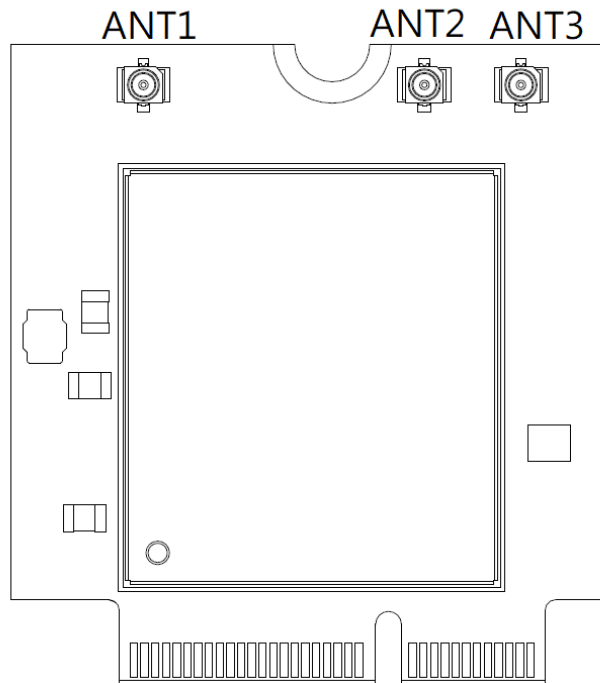

1.3 Specifications Table

1.3.1 General

Features	Description
Product Description	IEEE 802.11 2X2 WiFi 6 MIMO Wireless LAN + Bluetooth 5.1 Combo LGA Module
Major Chipset	NXP 88W9098 (DR-QFN 148pin)
Host Interface	WiFi + BT ● PCIe2.0 + UART
Dimension	28 mm X 30 mm x 3.95 mm(Max) (Tolerance remarked in mechanical drawing)
Form factor	Alternative sized M.2 2230 Key E
Antenna	2T2R for WiFi, standalone antenna for BT IPEX MHF4 connector Receptacle (20449) ANT1(Main) : WiFi_A → TX/RX ANT2(Aux) : WiFi_B → TX/RX ANT3(BT): BT
Weight	0.004 kg

1.3.2 WLAN

Features	Description
WLAN Standard	IEEE 802.11 a/b/g/n/ac/ax 2T2R
Frequency Range	2.4 GHz ISM Bands 2.412-2.472 GHz 5.15-5.25 GHz (FCC UNII-low band) for US/Canada and Europe 5.25-5.35 GHz (FCC UNII-middle band) for US/Canada and Europe 5.47-5.725 GHz for Europe 5.725-5.825 GHz (FCC UNII-high band) for US/Canada
Modulation	DSSS, OFDM, DBPSK, DQPSK, CCK, 16-QAM, 64-QAM, 256QAM, 1024QAM, OFDMA
Number of Channels	2.4GHz: <ul style="list-style-type: none"> ■ USA, NORTH AMERICA, Canada and Taiwan - 1 ~ 11 ■ China, Australia, Most European Countries - 1 ~ 13 ■ Japan, 1 ~ 13 5GHz: <ul style="list-style-type: none"> ■ USA, Canada, Most European Countries - 36,40,44,48,52,56,60,64,100,104,108,112,116,120,124,128,132,136,140,149,153,157,161,165 ■ Japan -

	36,40,44,48,52,56,60,64,100,104,108,112,116,120,124,128,132,136,140				
	■ China - 36,40,44,48,52,56,60,64, 149,153,157,161,165				
Output Power	2.4G				
		Min	Typ	Max	Unit
	11b (11Mbps) @EVM<35%	16	18	20	dBm
	11g (54Mbps) @EVM \leq -27 dB	15.5	17	18.5	dBm
	11n (HT20 MCS7) @EVM \leq -28 dB	14.5	16	17.5	dBm
	11n (HT40 MCS7) @EVM \leq -28 dB	14.5	16	17.5	dBm
	11ax (HE20 MCS11) @EVM \leq -35 dB	12.5	14	15.5	dBm
	11ax (HE40 MCS11) @EVM \leq -35 dB	12.5	14	15.5	dBm
	5G				
		Min	Typ	Max	Unit
	11a (54Mbps) @EVM \leq -27 dB	14	16	18	dBm
	11n (HT20 MCS7) @EVM \leq -28 dB	14	16	18	dBm
	11n (HT40 MCS7) @EVM \leq -28 dB	14	16	18	dBm
	11ac(VHT20 MCS8) @EVM \leq -31 dB	13	15	17	dBm
	11ac(VHT40 MCS9) @EVM \leq -32 dB	13	15	17	dBm
	11ac(VHT80 MCS9) @EVM \leq -32 dB	13	15	17	dBm
	11ax(HE20 MCS11) @EVM \leq -35 dB	10	12	14	dBm
	11ax(HE40 MCS11) @EVM \leq -35 dB	10	12	14	dBm
	11ax(HE80 MCS11) @EVM \leq -35 dB	10	12	14	dBm

Receiver Sensitivity	2.4G				
		Min	Typ	Max	Unit
	11b (11Mbps)	-	-88	-85	dBm
	11g (54Mbps)	-	-75	-72	dBm
	11n (HT20 MCS7)	-	-72	-69	dBm
	11n (HT40 MCS7)	-	-70	-66	dBm
	11ax(HE20 MCS11)	-	-62	-58	dBm
	11ax(HE40 MCS11)	-	-59	-53	dBm
	5G				
		Min	Typ	Max	Unit
	11a (54Mbps)	-	-72	-68	dBm
	11n (HT20 MCS7)	-	-70	-66	dBm
	11n (HT40 MCS7)	-	-68	-64	dBm
	11ac(VHT20 MCS8)	-	-65	-61	dBm
	11ac(VHT40 MCS9)	-	-62	-58	dBm
	11ac(VHT80 MCS9)	-	-59	-55	dBm
	11ax(HE20 MCS11)	-	-60	-56	dBm
11ax(HE40 MCS11)	-	-57	-53	dBm	
11ax(HE80 MCS11)	-	-55	-51	dBm	
Data Rate	<ul style="list-style-type: none"> ■ 802.11b: 1, 2, 5.5, 11Mbps ■ 802.11a/g: 6, 9, 12, 18, 24, 36, 48, 54Mbps ■ 802.11n: up to 150Mbps-single ■ 802.11n: up to 300Mbps-2x2 MIMO ■ 802.11ac: up to 192.6Mbps (20MHz channel) ■ 802.11ac: up to 400Mbps (40MHz channel) ■ 802.11ac: up to 866.7Mbps (80MHz channel) ■ 802.11ax: 2.4GHz up to 458Mbps, 5GHz up to 1.2Gbps 				
Security	WiFi: WPA/WPA2/WPA3				

* If you have any certification questions about output power please contact FAE directly.

1.3.3 Bluetooth

Features	Description
Bluetooth Standard	Bluetooth 5.1
Bluetooth VID/PID	N/A
Frequency Range	2402MHz~2483MHz
Modulation	Header GFSK Payload 2M: $\pi/4$ -DQPSK Payload 3M: 8DPSK

Output Power		Min	Typ	Max	Unit
	BDR	0	2	4	dBm
	EDR	0	2	4	dBm
	Low Energy (1MHz)	0	2	4	dBm
	Low Energy (2MHz)	0	2	4	dBm
Receiver Sensitivity		Min	Typ	Max	Unit
	BDR	-	-90	-87	dBm
	EDR	-	-87	-84	dBm
	Low Energy (1MHz)	-	-86	-83	dBm
	Low Energy (2MHz)	-	-85	-82	dBm

1.3.4 Operating Conditions

Features	Description
Operating Conditions	
Voltage	3.3V+-5%
Operating Temperature	-40°C~ 85°C
Operating Humidity	less than 85% R.H.
Storage Temperature	-40°C~ 85°C
Storage Humidity	less than 60% R.H.

2.1 Pin Table

Pin No.	Definition	Basic Description	Voltage	Type
1	GND	Ground.		GND
2	VDD33	3.3V power supply	3.3V	VCC
3	NC	NC		Floating
4	VDD33	3.3V power supply	3.3V	VCC
5	NC	NC		Floating
6	NC	NC		Floating
7	GND	Ground.		GND
8	PCM_CLK	PCM_CLK, GPIO Mode : GPIO[6].	1.8V	I/O
9	NC	NC		Floating
10	PCM_SYNC	PCM_SYNC, GPIO Mode : GPIO[7].	1.8V	I/O
11	NC	NC		Floating
12	PCM_OUT	PCM_OUT, GPIO Mode : GPIO[5].	1.8V	I/O
13	NC	NC		Floating
14	PCM_DIN	PCM_DIN, GPIO Mode : GPIO[4].	1.8V	I/O
15	NC	NC		Floating
16	NC	NC		Floating
17	NC	NC		Floating
18	GND	Ground.		GND
19	NC	NC		Floating
20	UART WAKE#	BT WAKE HOST, GPIO Mode : GPIO[16].	3.3V	I
21	NC	NC		Floating
22	UART_TX	UART SOUT pin	1.8V	Output
23	NC	NC		Floating
32	UART_RX	UART SIN.pin	1.8V	Input
33	GND	Ground.		GND
34	UART_RTSn	UART Mode: UART_RTSn (active low)	1.8V	Output
35	PERp0	PCIe Differential receive.	1.8V	Input
36	UART_CTSn	UART Mode: UART_CTSn (active low)	1.8V	Input
37	PERn0	PCIe Differential receive.	1.8V	Input
38	JTAG_TDO	JTAG_TDO, GPIO Mode :GPIO[31]	1.8V	O
39	GND	Ground.		GND
40	WLAN WAKE	DEV WLAN WAKE, GPIO Mode :GPIO[12]	1.8V	O
41	PETp0	PCIe Differential transmit.	1.8V	Output
42	BT WAKE	DEV BT WAKE, GPIO Mode :GPIO[1]	1.8V	O
43	PETn0	PCIe Differential transmit.	1.8V	Output
44	JTAG_TDI	JTAG_TDI, GPIO Mode :GPIO[30]	1.8V	I
45	GND	Ground.		GND
46	JTAG_TCK	JTAG_TCK, GPIO Mode :GPIO[28]	1.8V	I/O
47	REFCLKP	PCIe Differential reference clock.	1.8V	Input

48	JTAG_TMS	JTAG_TMS, GPIO Mode :GPIO[29]	1.8V	I/O
49	REFCLKN	PCIe Differential reference clock.	1.8V	Input
50	NC	NC		Floating
51	GND	Ground.		GND
52	PERST0	PCI Express Reset Signal: active low.	3.3V	Input
53	CLKREQ0	Reference clock request	3.3V	Output
54	W_DISABLE2_N	BT_INDEPENDENT_RESET	1.8V	I/O
55	PEWAKE#	Open Drain active Low signal. This signal is used to request that the system return from a sleep/suspended state to service a function initiated wake event.	3.3V	OUT
56	W_DISABLE1#	Pull power down for WLAN/BT	3.3V	IN
57	GND	Ground.		GND
58	NC	NC		Floating
59	NC	NC		Floating
60	NC	NC		Floating
61	NC	NC		Floating
62	NC	NC		Floating
63	GND	Ground.		GND
64	NC	NC		Floating
65	NC	NC		Floating
66	NC	NC		Floating
67	NC	NC		Floating
68	NC	NC		Floating
69	GND	Ground.		GND
70	NC	NC		Floating
71	NC	NC		Floating
72	VDD33	3.3V power supply	3.3V	VCC
73	NC	NC		Floating
74	VDD33	3.3V power supply	3.3V	VCC
75	GND	Ground.		GND
76	GND	Ground.		GND

3. Electrical Characteristics

3.1 Absolute Maximum Ratings

Symbol	Parameter	Minimum	Typical	Maximum	Unit
3V3	DC supply for the 3.3V input	-	3.3	3.63	V

3.2 Recommended Operating Conditions

Symbol	Parameter	Minimum	Typical	Maximum	Unit
3.3V	DC supply for the 3.3V input	3.14	3.3	3.46	V

3.3 Digital IO Pin DC Characteristics

3.3.1 1.8V Operation (VIO)

Symbol	Parameter	Minimum	Typical	Maximum	Unit
V _{IH}	Input high voltage	0.7*VIO	-	VIO+0.4	V
V _{IL}	Input low voltage	-0.4	-	0.3*VIO	
V _{OH}	Output high voltage	VIO-0.4	-	-	
V _{OL}	Output low voltage	-	-	0.4	
V _{HYS}	Input Hysteresis	100			mV

3.3.2 1.8V Operation (VIO_SD)

Symbol	Parameter	Minimum	Typical	Maximum	Unit
V _{IH}	Input high voltage	0.7*VIO_SD	-	VIO_SD+0.4	V
V _{IL}	Input low voltage	-0.4	-	0.3*VIO_SD	
V _{OH}	Output High Voltage	VIO_SD-0.4	-	-	
V _{OL}	Output Low Voltage	-	-	0.4	
V _{HYS}	Input Hysteresis	100			mV

3.4 Host Interface

3.4.1 PCI Express Interface

3.4.1.1 Differential Tx Output Electricals

Symbol	Parameter	Min	Typ	Max	Units
UI	Unit interval Each UI is 400 ps \pm 300 PPM. UI does not account for SSC dictated variations.	399.98	400	400.12	ps
V _{Tx_DIFFpp}	Differential peak-to-peak output voltage $V_{Tx_DIFFpp} = 2 * V_{Tx_D+} - V_{Tx_D-} $	0.800	--	1.2	V
V _{Tx_DE_RATIO}	De-emphasized differential output voltage (ratio)	-3.0	-3.5	-4.0	db
T _{Rx_EYE}	Minimum Tx eye width	0.75	--	--	UI
T _{Rx_EYE_MEDIAN_MAX_JIT}	Maximum time between jitter median and maximum deviation from median	--	--	0.125	UI
T _{Tx_RISE} , T _{Tx_FALL}	D+/D- Tx output rise/fall time	0.125	--	--	UI
V _{Tx_CM_DC_ACTIVE_IDLE_DELTA}	Absolute delta of DC common mode voltage during L0 and electrical idle	0-	-	100	mV
V _{Tx_CM_DC_LINE_DELTA}	Absolute delta of DC common mode voltage between D+ and D-	0-	-	25	mV
V _{Tx_IDLE_DIFFp}	Electrical idle differential peak output voltage	0	--	20	mV
V _{Tx_RCV_DETECT}	Voltage change allowed during receiver detection	--	--	600	mV
V _{Tx_DC_CM}	Tx DC common mode voltage	--	--	3.6	V
I _{Tx_SHORT}	Tx short circuit current limit	--	--	90	mA
T _{Tx_IDLE_MIN}	Minimum time spent in electrical idle	50	--	--	UI
T _{Tx_IDLE_SET_TO_IDLE}	Maximum time to transition to a valid electrical idle after sending an electrical idle ordered set	--	--	20	UI
T _{Tx_IDLE_TO_DIFF_DATA}	Maximum time to transition to valid Tx specifications after leaving an electrical idle condition	--	--	20	UI
RL _{Tx_DIFF}	Differential return loss	10	--	--	dB
RL _{Tx_CM}	Common mode return loss	6	--	--	dB
C _{Tx}	AC coupling capacitor	75	--	200	nF
T _{Crosstalk}	Crosstalk random timeout	0	--	1	ms

3.4.1.2 Differential Rx Input Electricals

Symbol	Parameter	Min	Typ	Max	Units
UI	Unit interval Each UI is 400 ps \pm 300 ppm. UI does not account for SSC dictated variations.	399.98	400	400.12	ps
V_{RX_DIFFpp}	Differential peak-to-peak voltage $V_{RX_DIFFpp} = 2 * V_{RX-D+} - V_{RX-D-} $	0.175	--	1.2	V
T_{RX_EYE}	Minimum receiver eye width	0.4	--	--	UI
$T_{RX_EYE_MEDIAN_MAX_JIT}$	Maximum time between jitter median and maximum deviation from median	--	--	0.3	UI
$V_{RX_CM_ACp}$	AC peak common mode input voltage	--	--	150	mV
RL_{RX_DIFF}	Differential return loss	10	--	--	dB
RL_{RX_CM}	Common mode return loss	6	--	--	dB
$Z_{RX_DIFF_DC}$	DC differential input impedance	80	100	120	Ω
Z_{RX_DC}	DC input impedance	40	50	60	Ω
$Z_{RX_HIGH_IMP_DC_POS}$	Powered down DC input impedance positive	50	--	--	k
$Z_{RX_HIGH_IMP_DC_NEG}$	Powered down DC input impedance negative	1	--	--	k Ω
$V_{RX_IDLE_DET_DIFFpp}$	Electrical idle detect threshold	65	--	175	mV
$T_{RX_IDLE_DET_DIFF_ENTERTIME}$	Unexpected electrical idle enter detect threshold integration time	--	--	10	ms
L_{RX_SKEW}	Total skew	---	-2	0	ns

3.4.2.High-Speed UART Interface

The AW-XM458MA-PUR supports a high-speed Universal Asynchronous Receiver/Transmitter (UART) interface, compliant to the industry standard 16550 specification. High-speed baud rates are supported to provide the physical transport between the device and the host for exchanging Bluetooth data.

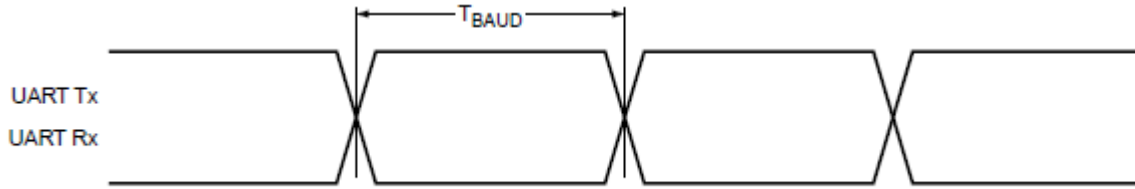

Symbol	Parameter	Condition	Min	Typ	Max	Units
T_{BAUD}	Baud rate	26MHz input clock	250	-	-	ns

3.5 Timing Sequence

AW-XM458MA-PUR power up timing sequence.

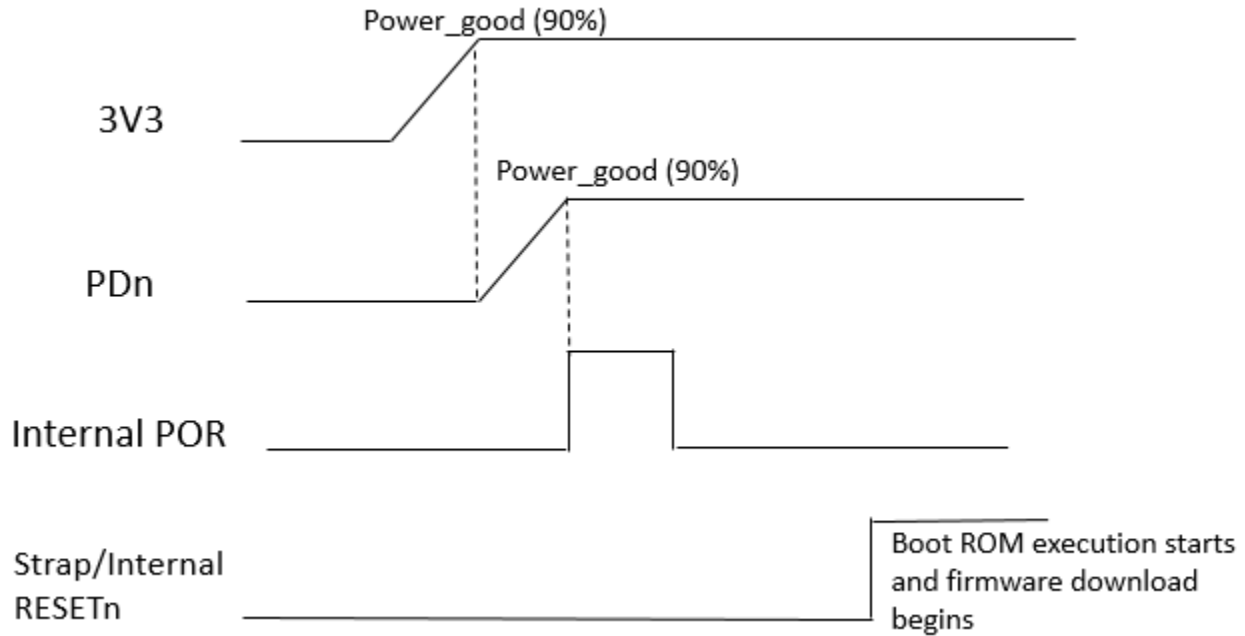

3.6 Power Consumption*

3.6.1 WLAN

No.	Item			3.3V(mA)		
				Max.	Avg.	
1	Power down			0.254		
2	DeepSleep (Not associated with AP)			1.77	1.69	
3	Power Save (2.4GHz)			124	5.45	
4	Power Save (5GHz)			165	4.18	
Band (GHz)	Mode	BW (MHz)	RF Power (dBm)	Transmit		
				Max.	Avg.	Duty (%)
2.4	11b@1Mbps	20	18	467	466	99
	11g@6Mbps	20	17	428	427	99
	11n@MCS8 MIMO	40	16	648	641	88
	11n@MCS15 MIMO	40	16	584	582	70
	11ax@MCS11 NSS2	40	14	544	542	75
5	11a@6Mbps	20	16	488	485	99
	11n@MCS8 MIMO	40	16	870	856	88
	11n@MCS15 MIMO	40	16	785	784	70
	11ac@MCS0 NSS2	80	15	844	835	88
	11ac@MCS9 NSS2	80	15	752	750	66
	11ax@MCS0 NSS2	80	12	820	816	80
	11ax@MCS11 NSS2	80	12	751	750	57
Concurrent	11n@MCS0 MIMO(2.4G) + 11ax@MCS0 NSS2(5G)	40 + 80	16 + 14	1312	1288	96
	11ac@MCS0 NSS2(5G) + 11ax@MCS0 NSS2(2.4G)	40 + 40	15 + 16	1215	1198	96
Band (GHz)	Mode	BW(MHz)	Receive			
			Max.	Avg.		
2.4	11b@1Mbps	20	194	167		
	11ax@MCS0	40	211	203		
5	11a@6Mbps	20	231	225		
	11ax@MCS0 NSS1	80	248	242		

3.6.2 Bluetooth

No.	Mode	RF Power (dBm)	3.3V(mA)	
			Max.	Avg.
1	Deepsleep	N/A	17.8	1.78
2	Transmit (DH5)	2	30.0	29.0
3	Receiver (3DH5)	N/A	30.1	27.2

4. Mechanical Information

4.1 Mechanical Drawing

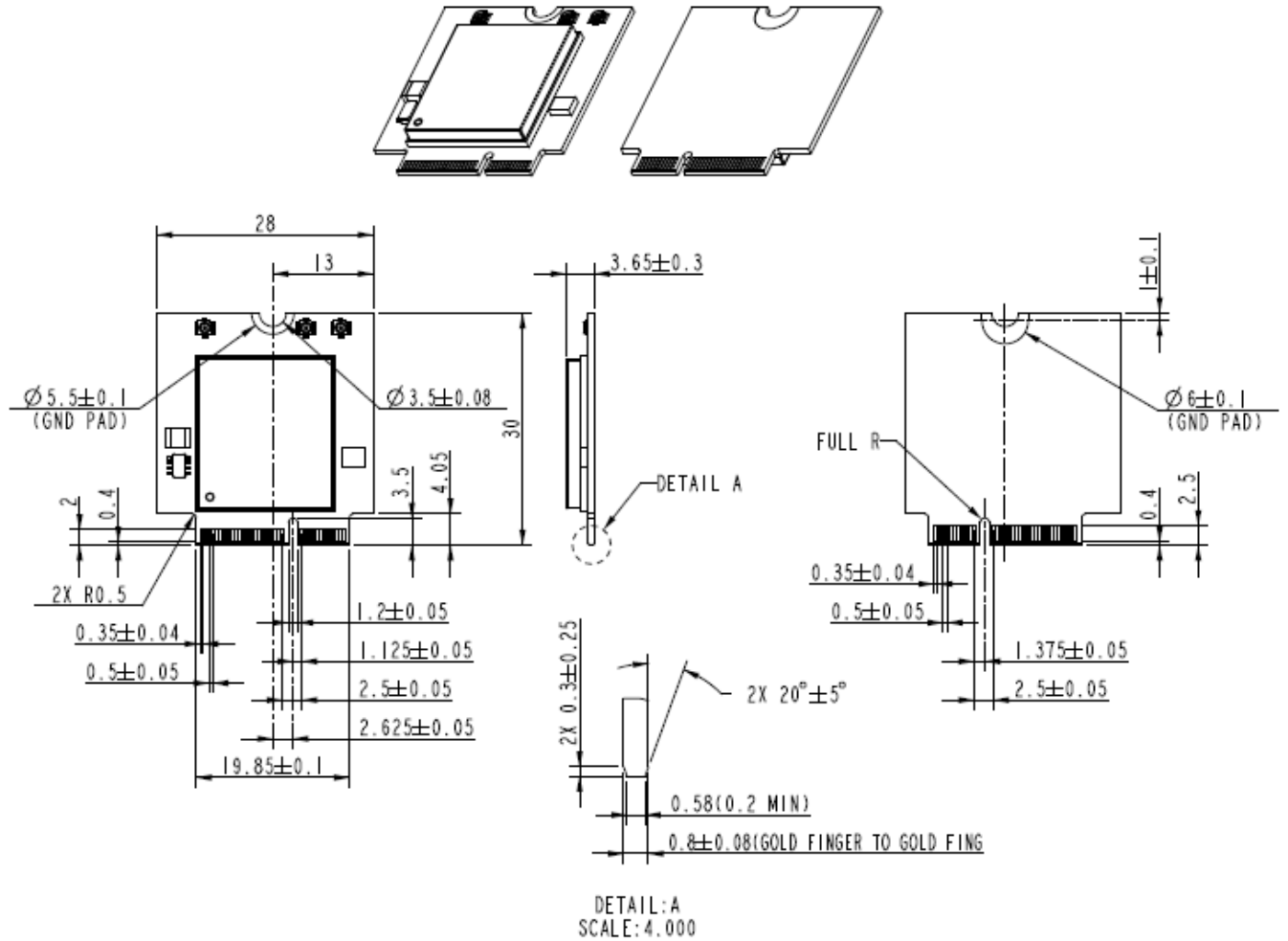

TOLERANCES UNLESS OTHERWISE SPECIFIED: $\pm 0.15\text{mm}$

(Draft drawing)

5. Packing Information

1. 160pcs modules put in the one bottom tray



2. One cover tray put on bottom tray



3. **4pcs tray** (cover + bottom) stacked together



4. Use P.P Strap to pack 4 trays



5. Put packed trays into inner box
640pcs/box



6. Seal the inner box by AzureWave tape



7. One package label pasted in side of inner box



8. Two inner boxes put into one carton; 1280pcs/carton
If only one inner box has modules, "Empty" label pasted on the other one inner box









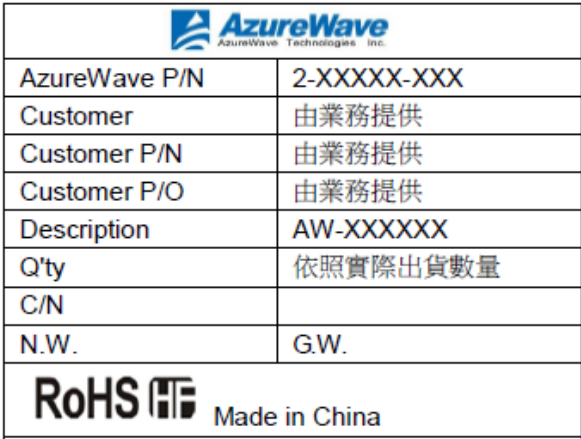

Example:

9. Seal the carton by AzureWave tape



10. One carton label and box label pasted on the carton. If the carton is not full, one balance label pasted on the carton



<p>Example of carton label (出貨標籤的範例)</p>	 <table border="1" data-bbox="727 919 1304 1354"> <tr> <td colspan="2" style="text-align: center;"></td> </tr> <tr> <td>AzureWave P/N</td> <td>2-XXXXX-XXX</td> </tr> <tr> <td>Customer</td> <td>由業務提供</td> </tr> <tr> <td>Customer P/N</td> <td>由業務提供</td> </tr> <tr> <td>Customer P/O</td> <td>由業務提供</td> </tr> <tr> <td>Description</td> <td>AW-XXXXXX</td> </tr> <tr> <td>Q'ty</td> <td>依照實際出貨數量</td> </tr> <tr> <td>C/N</td> <td></td> </tr> <tr> <td>N.W.</td> <td>G.W.</td> </tr> <tr> <td colspan="2" style="text-align: center;">RoHS  Made in China</td> </tr> </table>			AzureWave P/N	2-XXXXX-XXX	Customer	由業務提供	Customer P/N	由業務提供	Customer P/O	由業務提供	Description	AW-XXXXXX	Q'ty	依照實際出貨數量	C/N		N.W.	G.W.	RoHS  Made in China	
																					
AzureWave P/N	2-XXXXX-XXX																				
Customer	由業務提供																				
Customer P/N	由業務提供																				
Customer P/O	由業務提供																				
Description	AW-XXXXXX																				
Q'ty	依照實際出貨數量																				
C/N																					
N.W.	G.W.																				
RoHS  Made in China																					
<p>Example of box label (箱號標籤)</p>	 <p style="text-align: center;">2-XXXXX-XXX 数量: XXX BOX0275351 XXXXXX 股份有限公司</p>																				
<p>Example of balance label (尾數標籤)</p>	 <p style="text-align: center; font-size: 2em;">尾数 Balance</p>																				