



正基科技股份有限公司

## SPECIFICATION

SPEC. NO. : \_\_\_\_\_ REV : 1.1

DATE : 03.06.2015

PRODUCT NAME : AP6354

	APPROVED	CHECKED	PREPARED	DCC ISSUE
NAME				

AMPAK

AP6354

2x2 WiFi + Bluetooth4.1  
Module Spec Sheet

# Revision History

Date	Revision Content	Revised By	Version
2014/05/08	-Preliminary	Brian	1.0
2015/03/06	-Pin definition modified	Dora	1.1

AMPAK  
Confidential

# Contents

<b>Contents .....</b>	<b>2</b>
<b>1. Introduction.....</b>	<b>4</b>
<b>2. Features.....</b>	<b>5</b>
<b>3. Deliverables .....</b>	<b>6</b>
3.1 Deliverables.....	6
3.2 Regulatory certifications .....	6
<b>4. General Specification .....</b>	<b>7</b>
4.1 General Specification.....	7
4.2 Voltages.....	7
4.2.1 Absolute Maximum Ratings.....	7
4.2.2 Recommended Operating Rating .....	7
The module requires two power supplies: VBAT and VDDIO.....	7
<b>5. WiFi RF Specification .....</b>	<b>8</b>
5.1 2.4GHz RF Specification.....	8
5.2 5GHz RF Specification.....	10
<b>6. Bluetooth Specification.....</b>	<b>15</b>
6.1 Bluetooth Specification .....	15
<b>7. Pin Assignments.....</b>	<b>16</b>
7.1 Pin Outline .....	16
7.2 Pin Definition .....	16
<b>8. Dimensions .....</b>	<b>18</b>
8.1 Physical Dimensions .....	18
8.2 Layout Recommendation.....	19
<b>9. External clock reference .....</b>	<b>20</b>
9.1 SDIO Pin Description.....	20
<b>10. Host Interface Timing Diagram.....</b>	<b>21</b>
10.1 Power-up Sequence Timing Diagram .....	21
10.2 SDIO Default Mode Timing Diagram.....	23
10.3 SDIO High Speed Mode Timing Diagram .....	24
10.4 SDIO Bus Timing Specifications in SDR Modes .....	25
10.5 SDIO Bus Timing Specifications in DDR50 Mode.....	27
<b>11. Recommended Reflow Profile .....</b>	<b>28</b>
<b>12. Package Information.....</b>	<b>29</b>
12.1 Label.....	29
<b>Label C→ Inner box label . .....</b>	<b>29</b>
<b>Label D→ Carton box label . .....</b>	<b>29</b>
12.2 Dimension.....	30

12.3 MSL Level / Storage Condition ..... 32

AMPAK  
Confidential

# 1. Introduction

AMPAK Technology would like to announce a low-cost and low-power consumption module which has all of the WiFi and Bluetooth functionalities. The highly integrated module makes the possibilities of web browsing, VoIP, Bluetooth headsets applications. With seamless roaming capabilities and advanced security, also could interact with different vendors' 802.11 a/b/g/n/ac 2x2 Access Points in the wireless LAN.

The wireless module complies with IEEE 802.11 a/b/g/n/ac 2x2 MIMO standard and it can achieve up to a speed of 867Mbps with dual stream in 802.11n to connect the wireless LAN. The integrated module provides SDIO interface for WiFi, UART / PCM interface for Bluetooth.

This compact module is a total solution for a combination of WiFi + BT technologies. The module is specifically developed for Smart phones and Portable devices.

## 2. Features

- Lead Free design which is compliant with ROHS requirements.
- 802.11a/b/g/n/ac dual-band radio with virtual-simultaneous dual-band operation
- Dual-stream spatial multiplexing up to 867 Mbps data rate.
- Supports 20, 40, 80 MHz channels with optional SGI(256 QAM modulation)
- Supports IEEE 802.11 ac/n beam forming.
- Supports IEEE 802.15.2 external coexistence interface to optimize bandwidth utilization with other co-located wireless technologies such as LTE, GPS, or WiMAX.
  - Supports standard SDIO interfaces.
- BT host digital interface:
  - HCI UART (up to 4 Mbps)
  - PCM for audio data
- Complies with Bluetooth Core Specification Version 4.1 with provisions for supporting future specifications. With Bluetooth Class 1 or Class2 transmitter operation.
- Supports extended synchronous connections (eSCO), for enhanced voice quality by allowing for retransmission of dropped packets.
- Adaptive frequency hopping (AFH) for reducing radio frequency interference.

A simplified block diagram of the module is depicted in the figure below.

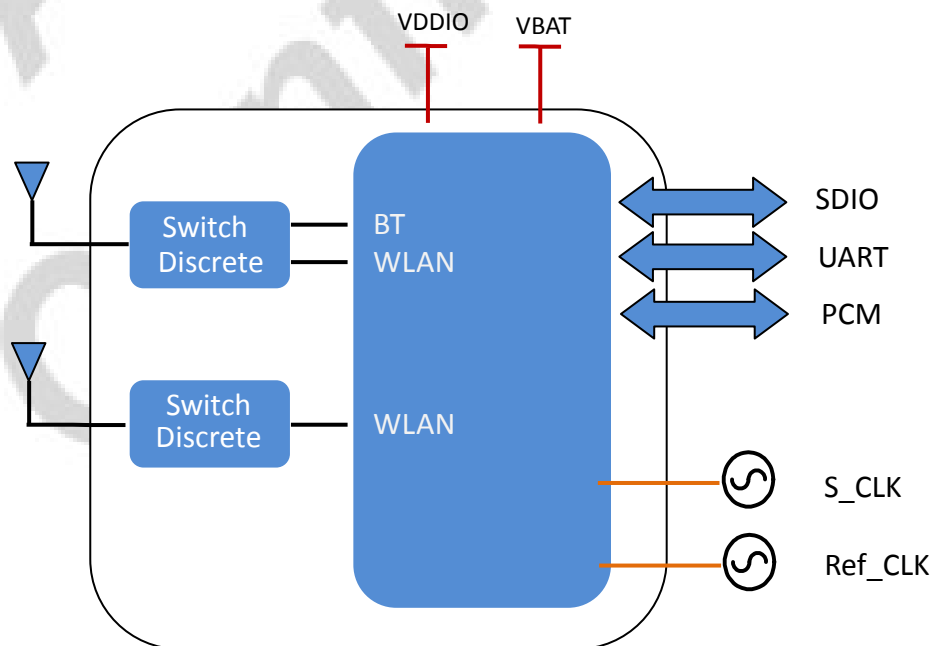

## 3. Deliverables

### 3.1 Deliverables

The following products and software will be part of the product.

- Module with packaging
- Evaluation Kits
- Software utility for integration, performance test.
- Product Datasheet.
- Agency certified pre-tested report with the adapter board.

### 3.2 Regulatory certifications

The product delivery is a pre-tested module, without the module level certification. For module approval, the platform's antennas are required for the certification.

## 4. General Specification

### 4.1 General Specification

Model Name	AP6354
Product Description	Support WiFi/Bluetooth functionalities
Dimension	L x W x H: 15 x 13 x 1.5 (typical) mm
WiFi Interface	Support SDIO V3.0
BT Interface	UART / PCM
Operating temperature	-10°C to 65°C
Storage temperature	-40°C to 85°C
Humidity	Operating Humidity 10% to 95% Non-Condensing

### 4.2 Voltages

#### 4.2.1 Absolute Maximum Ratings

Symbol	Description	Min.	Max.	Unit
VBAT	Input supply Voltage	-0.5	5.5	V
VDDIO	Digital/Bluetooth/SDIO/ I/O Voltage	-0.5	3.8	V

#### 4.2.2 Recommended Operating Rating

The module requires two power supplies: VBAT and VDDIO.

	Min.	Typ.	Max.	Unit
Operating Temperature	-10	25	65	deg.C
VBAT	3.0	3.6	4.8	V
VDDIO	1.7	-	3.6	V

## 5. WiFi RF Specification

### 5.1 2.4GHz RF Specification

Conditions : VBAT=3.6V ; VDDIO=3.3V ; Temp:25°C

Feature	Description
WLAN Standard	IEEE 802.11a/b/g/n/ac WiFi compliant
Frequency Range	2.400 GHz ~ 2.497 GHz (2.4 GHz ISM Band)
Number of Channels	2.4GHz : Ch1 ~ Ch14
Modulation	802.11b : DQPSK, DBPSK, CCK 802.11 g/n : OFDM /64-QAM,16-QAM, QPSK, BPSK
Output Power	802.11b /11Mbps : 16 dBm ± 1.5 dB @ EVM ≤ -9dB
	802.11g /54Mbps : 15 dBm ± 1.5 dB @ EVM ≤ -25dB
	802.11n /MCS7 : 14 dBm ± 1.5 dB @ EVM ≤ -28dB
	802.11ac/256-QAM(R=3/4) : 13 dBm ± 1.5 dB @ EVM ≤ -30dB
	802.11ac/256-QAM(R=5/6) : 11 dBm ± 1.5 dB @ EVM ≤ -32dB
SISO Receive Sensitivity (11b,20MHz) @8% PER	- 1Mbps PER @ -92 dBm, typical
	- 2Mbps PER @ -90 dBm, typical
	- 5.5Mbps PER @ -87 dBm, typical
	- 11Mbps PER @ -85 dBm, typical
SISO Receive Sensitivity (11g,20MHz) @10% PER	- 6Mbps PER @ -89 dBm, typical
	- 9Mbps PER @ -88 dBm, typical
	- 12Mbps PER @ -87 dBm, typical
	- 18Mbps PER @ -84 dBm, typical
	- 24Mbps PER @ -81 dBm, typical
	- 36Mbps PER @ -78 dBm, typical
	- 48Mbps PER @ -73 dBm, typical
- 54Mbps PER @ -71 dBm, typical	
MIMO Receive Sensitivity (11g,20MHz) @10% PER	- 6Mbps PER @ -91 dBm, typical
	- 9Mbps PER @ -90 dBm, typical
	- 12Mbps PER @ -89 dBm, typical
	- 18Mbps PER @ -87 dBm, typical
	- 24Mbps PER @ -84 dBm, typical
	- 36Mbps PER @ -81 dBm, typical
	- 48Mbps PER @ -76 dBm, typical
- 54Mbps PER @ -74 dBm, typical	

SISO Receive Sensitivity (11n,20MHz) @10% PER	- MCS=0 PER @ -89 dBm, typical
	- MCS=1 PER @ -86 dBm, typical
	- MCS=2 PER @ -84 dBm, typical
	- MCS=3 PER @ -80 dBm, typical
	- MCS=4 PER @ -77 dBm, typical
	- MCS=5 PER @ -72 dBm, typical
	- MCS=6 PER @ -71 dBm, typical
	- MCS=7 PER @ -69 dBm, typical
MIMO Receive Sensitivity (11n,20MHz) @10% PER	- MCS=0 PER @ -90 dBm, typical
	- MCS=1 PER @ -89 dBm, typical
	- MCS=2 PER @ -87 dBm, typical
	- MCS=3 PER @ -84 dBm, typical
	- MCS=4 PER @ -80 dBm, typical
	- MCS=5 PER @ -75 dBm, typical
	- MCS=6 PER @ -73 dBm, typical
	- MCS=7 PER @ -72 dBm, typical
	- MCS=8 PER @ -87 dBm, typical
- MCS=15 PER @ -68 dBm, typical	
SISO Receive Sensitivity (11ac,20MHz) @10% PER	- MCS=0, NSS1 PER @ -88 dBm, typical
	- MCS=1, NSS1 PER @ -85 dBm, typical
	- MCS=2, NSS1 PER @ -84 dBm, typical
	- MCS=3, NSS1 PER @ -80 dBm, typical
	- MCS=4, NSS1 PER @ -77 dBm, typical
	- MCS=5, NSS1 PER @ -72 dBm, typical
	- MCS=6, NSS1 PER @ -70 dBm, typical
	- MCS=7, NSS1 PER @ -69 dBm, typical
	- MCS=8, NSS1 PER @ -66 dBm, typical
MIMO Receive Sensitivity (11ac,20MHz) @10% PER	- MCS=0, NSS1 PER @ -88 dBm, typical
	- MCS=1, NSS1 PER @ -87 dBm, typical
	- MCS=2, NSS1 PER @ -86 dBm, typical
	- MCS=3, NSS1 PER @ -83 dBm, typical
	- MCS=4, NSS1 PER @ -80 dBm, typical
	- MCS=5, NSS1 PER @ -75 dBm, typical
	- MCS=6, NSS1 PER @ -74 dBm, typical
	- MCS=7, NSS1 PER @ -72 dBm, typical
	- MCS=8, NSS1 PER @ -68 dBm, typical
- MCS=0, NSS2 PER @ -88 dBm, typical	

	- MCS=8, NSS2 PER @ -64 dBm, typical
Maximum Input Level	802.11b : -10 dBm
	802.11g/n : -20 dBm
Antenna Reference	Small antennas with 0~2 dBi peak gain

## 5.2 5GHz RF Specification

Conditions : VBAT=3.6V ; VDDIO=3.3V ; Temp:25°C

Feature	Description
WLAN Standard	IEEE 802.11a/n 2x2, WiFi compliant
Frequency Range	4.900 GHz ~ 5.845 GHz (5.0 GHz ISM Band)
Number of Channels	5.0GHz : Please see the table <sup>1</sup>
Modulation	802.11a : OFDM /64-QAM,16-QAM, QPSK, BPSK 802.11n : OFDM /64-QAM,16-QAM, QPSK, BPSK 802.11ac : OFDM /256-QAM
Output Power	802.11a /54Mbps : 13 dBm ± 1.5 dB @ EVM ≤ -25dB
	802.11n /MCS7 : 12 dBm ± 1.5 dB @ EVM ≤ -28dB
	802.11ac /MCS9 : 10 dBm ± 1.5 dB @ EVM ≤ -32dB
SISO Receive Sensitivity (11a,20MHz) @10% PER	- 6Mbps PER @ -88 dBm, typical
	- 9Mbps PER @ -87 dBm, typical
	- 12Mbps PER @ -86 dBm, typical
	- 18Mbps PER @ -83 dBm, typical
	- 24Mbps PER @ -80 dBm, typical
	- 36Mbps PER @ -77 dBm, typical
	- 48Mbps PER @ -72 dBm, typical
	- 54Mbps PER @ -70 dBm, typical
MIMO Receive Sensitivity (11a,20MHz) @10% PER	- 6Mbps PER @ -90 dBm, typical
	- 9Mbps PER @ -89 dBm, typical
	- 12Mbps PER @ -88 dBm, typical

	- 18Mbps PER @ -86 dBm, typical
	- 24Mbps PER @ -83 dBm, typical
	- 36Mbps PER @ -80 dBm, typical
	- 48Mbps PER @ -75 dBm, typical
	- 54Mbps PER @ -71 dBm, typical
SISO Receive Sensitivity (11n,20MHz) @10% PER	- MCS=0 PER @ -88 dBm, typical
	- MCS=1 PER @ -85 dBm, typical
	- MCS=2 PER @ -83 dBm, typical
	- MCS=3 PER @ -80 dBm, typical
	- MCS=4 PER @ -76 dBm, typical
	- MCS=5 PER @ -71 dBm, typical
	- MCS=6 PER @ -70 dBm, typical
MIMO Receive Sensitivity (11n,20MHz) @10% PER	- MCS=0 PER @ -89 dBm, typical
	- MCS=1 PER @ -88 dBm, typical
	- MCS=2 PER @ -86 dBm, typical
	- MCS=3 PER @ -83 dBm, typical
	- MCS=4 PER @ -79 dBm, typical
	- MCS=5 PER @ -74 dBm, typical
	- MCS=6 PER @ -73 dBm, typical
	- MCS=7 PER @ -71 dBm, typical
	- MCS=8 PER @ -88 dBm, typical
- MCS=15 PER @ -68 dBm, typical	
SISO Receive Sensitivity (11n,40MHz) @10% PER	- MCS=0 PER @ -85 dBm, typical
	- MCS=1 PER @ -82 dBm, typical
	- MCS=2 PER @ -80 dBm, typical
	- MCS=3 PER @ -77 dBm, typical
	- MCS=4 PER @ -73 dBm, typical
	- MCS=5 PER @ -69 dBm, typical
	- MCS=6 PER @ -67 dBm, typical
- MCS=7 PER @ -66 dBm, typical	
MIMO Receive Sensitivity (11n,40MHz) @10% PER	- MCS=0 PER @ -87 dBm, typical
	- MCS=1 PER @ -85 dBm, typical
	- MCS=2 PER @ -83 dBm, typical
	- MCS=3 PER @ -80 dBm, typical
	- MCS=4 PER @ -76 dBm, typical
	- MCS=5 PER @ -72 dBm, typical

	- MCS=6 PER @ -70 dBm, typical
	- MCS=7 PER @ -69 dBm, typical
	- MCS=8 PER @ -85 dBm, typical
	- MCS=15 PER @ -66 dBm, typical
SISO Receive Sensitivity (11ac,20MHz) @10% PER	- MCS=0, NSS1 PER @ -86 dBm, typical
	- MCS=1, NSS1 PER @ -84 dBm, typical
	- MCS=2, NSS1 PER @ -82 dBm, typical
	- MCS=3, NSS1 PER @ -79 dBm, typical
	- MCS=4, NSS1 PER @ -75 dBm, typical
	- MCS=5, NSS1 PER @ -70 dBm, typical
	- MCS=6, NSS1 PER @ -69 dBm, typical
	- MCS=7, NSS1 PER @ -68 dBm, typical
MIMO Receive Sensitivity (11ac,20MHz) @10% PER	- MCS=8, NSS1 PER @ -64 dBm, typical
	- MCS=0, NSS1 PER @ -88 dBm, typical
	- MCS=1, NSS1 PER @ -87 dBm, typical
	- MCS=2, NSS1 PER @ -85 dBm, typical
	- MCS=3, NSS1 PER @ -82 dBm, typical
	- MCS=4, NSS1 PER @ -78 dBm, typical
	- MCS=5, NSS1 PER @ -73 dBm, typical
	- MCS=6, NSS1 PER @ -72 dBm, typical
	- MCS=7, NSS1 PER @ -71 dBm, typical
	- MCS=8, NSS1 PER @ -67 dBm, typical
	- MCS=0, NSS2 PER @ -87 dBm, typical
	- MCS=8, NSS2 PER @ -63 dBm, typical
SISO Receive Sensitivity (11ac,40MHz) @10% PER	- MCS=0, NSS1 PER @ -84 dBm, typical
	- MCS=1, NSS1 PER @ -81 dBm, typical
	- MCS=2, NSS1 PER @ -79 dBm, typical
	- MCS=3, NSS1 PER @ -76 dBm, typical
	- MCS=4, NSS1 PER @ -73 dBm, typical
	- MCS=5, NSS1 PER @ -68 dBm, typical
	- MCS=6, NSS1 PER @ -67 dBm, typical
	- MCS=7, NSS1 PER @ -66 dBm, typical
	- MCS=8, NSS1 PER @ -61 dBm, typical
	- MCS=9, NSS1 PER @ -60 dBm, typical
MIMO Receive Sensitivity (11ac,40MHz) @10% PER	- MCS=0, NSS1 PER @ -86 dBm, typical
	- MCS=1, NSS1 PER @ -84 dBm, typical
	- MCS=2, NSS1 PER @ -82 dBm, typical

	- MCS=3, NSS1 PER @ -79 dBm, typical
	- MCS=4, NSS1 PER @ -76 dBm, typical
	- MCS=5, NSS1 PER @ -71 dBm, typical
	- MCS=6, NSS1 PER @ -70 dBm, typical
	- MCS=7, NSS1 PER @ -69 dBm, typical
	- MCS=8, NSS1 PER @ -64 dBm, typical
	- MCS=9, NSS1 PER @ -63 dBm, typical
	- MCS=0, NSS2 PER @ -84 dBm, typical
	- MCS=9, NSS2 PER @ -60 dBm, typical
SISO Receive Sensitivity (11ac,80MHz) @10% PER	- MCS=0, NSS1 PER @ -81 dBm, typical
	- MCS=1, NSS1 PER @ -78 dBm, typical
	- MCS=2, NSS1 PER @ -76 dBm, typical
	- MCS=3, NSS1 PER @ -72 dBm, typical
	- MCS=4, NSS1 PER @ -69 dBm, typical
	- MCS=5, NSS1 PER @ -66 dBm, typical
	- MCS=6, NSS1 PER @ -64 dBm, typical
	- MCS=7, NSS1 PER @ -62 dBm, typical
	- MCS=8, NSS1 PER @ -58 dBm, typical
	- MCS=9, NSS1 PER @ -56 dBm, typical
MIMO Receive Sensitivity (11ac,80MHz) @10% PER	- MCS=0, NSS1 PER @ -82 dBm, typical
	- MCS=1, NSS1 PER @ -81 dBm, typical
	- MCS=2, NSS1 PER @ -79 dBm, typical
	- MCS=3, NSS1 PER @ -75 dBm, typical
	- MCS=4, NSS1 PER @ -72 dBm, typical
	- MCS=5, NSS1 PER @ -69 dBm, typical
	- MCS=6, NSS1 PER @ -67 dBm, typical
	- MCS=7, NSS1 PER @ -65 dBm, typical
	- MCS=8, NSS1 PER @ -61 dBm, typical
	- MCS=9, NSS1 PER @ -60 dBm, typical
	- MCS=0, NSS2 PER @ -80 dBm, typical
	- MCS=9, NSS2 PER @ -56 dBm, typical
Maximum Input Level	802.11a/n : -30 dBm
Antenna Reference	Small antennas with 0~2 dBi peak gain

<sup>1</sup>5GHz(20MHz) Channel table

Band (GHz)	Operating Channel Numbers	Channel center frequencies(MHz)
5.15GHz~5.25GHz	36	5180
	40	5200
	44	5220
	48	5240
5.25GHz~5.35GHz	52	5260
	56	5280
	60	5300
	64	5320
5.5GHz~5.7GHz	100	5500
	104	5520
	108	5540
	112	5560
	116	5580
	120	5600
	124	5620
	128	5640
	132	5660
	136	5680
5.725GHz~5.825GHz	149	5745
	153	5765
	157	5785
	161	5805

## 6. Bluetooth Specification

### 6.1 Bluetooth Specification

Conditions : VBAT=3.6V ; VDDIO=3.3V ; Temp:25 °C

Feature	Description		
<b>General Specification</b>			
Bluetooth Standard	Bluetooth V4.1 of 1, 2 and 3 Mbps.		
Host Interface	UART		
Antenna Reference	Small antennas with 0~2 dBi peak gain		
Frequency Band	2402 MHz ~ 2480 MHz		
Number of Channels	79 channels		
Modulation	FHSS, GFSK, DPSK, DQPSK		
<b>RF Specification</b>			
	<b>Min.</b>	<b>Typical.</b>	<b>Max.</b>
Output Power (Class 1.5)		10 dBm	
Output Power (Class 2)		2 dBm	
Sensitivity @ BER=0.1% for GFSK (1Mbps)		-86 dBm	
Sensitivity @ BER=0.01% for $\pi/4$ -DQPSK (2Mbps)		-86 dBm	
Sensitivity @ BER=0.01% for 8DPSK (3Mbps)		-80 dBm	
Maximum Input Level	GFSK (1Mbps):-20dBm		
	$\pi/4$ -DQPSK (2Mbps) :-20dBm		
	8DPSK (3Mbps) :-20dBm		

# 7. Pin Assignments

## 7.1 Pin Outline

< TOP VIEW >

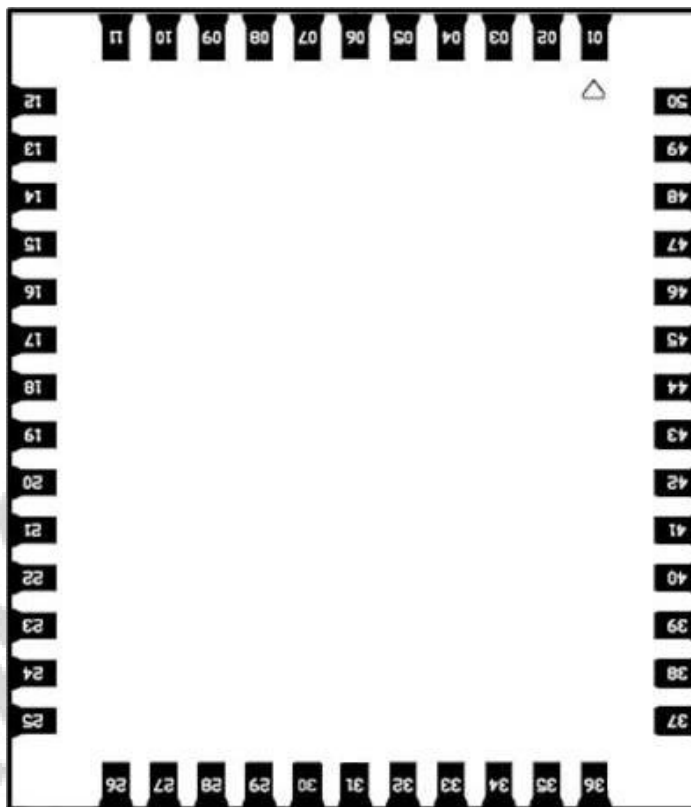

## 7.2 Pin Definition

NO	Name	Type	Description
1	GND	—	Ground connections
2	WL/BT_ANT0	I/O	RF I/O port0
3	GND	—	Ground connections
4	GND	—	Ground connections
5	GND	—	Ground connections
6	GND	—	Ground connections
7	GND	—	Ground connections
8	GND	—	Ground connections
9	WL_ANT1	I/O	RF I/O port1
10	GND	—	Ground connections
11	GND	—	Ground connections
12	NC	—	No connect
13	XTAL_OUT	O	External Crystal out

14	XTAL_IN	I	External Crystal in/ Single clock source in
15	WL_REG_ON	I	Low asserting reset for WiFi core
16	WL_HOST_WAKE	O	WLAN to wake-up HOST
17	SDIO_DATA_CMD	I/O	SDIO command line
18	SDIO_DATA_CLK	I/O	SDIO clock line
19	SDIO_DATA_3	I/O	SDIO data line 3
20	SDIO_DATA_2	I/O	SDIO data line 2
21	SDIO_DATA_0	I/O	SDIO data line 0
22	SDIO_DATA_1	I/O	SDIO data line 1
23	GND	—	Ground connections
24	NC	—	No connect
25	VIN_LDO	P	Internal Buck voltage generation pin
26	VIN_LDO_OUT	P	Internal Buck voltage generation pin
27	PCM_SYNC	I/O	PCM sync signal
28	PCM_IN	I	PCM data input
29	PCM_OUT	O	PCM Data output
30	PCM_CLK	I/O	PCM clock
31	LPO	I	External Low Power Clock input (32.768KHz)
32	GND	—	Ground connections
33	NC	—	No connect
34	VDDIO	P	I/O Voltage supply input
35	NC	—	No connect
36	VBAT	P	Main power voltage source input
37	NC	—	No connect
38	BT_REG_ON	I	Low asserting reset for Bluetooth core
39	GND	—	Ground connections
40	UART_TXD	O	Bluetooth UART interface
41	UART_RXD	I	Bluetooth UART interface
42	UART_RTS_N	O	Bluetooth UART interface
43	UART_CTS_N	I	Bluetooth UART interface
44	NC	—	No connect
45	GPIO5	I/O	LTE_TX
46	GPIO4	I/O	LTE_RX
47	NC	—	No connect
48	NC	—	No connect
49	BT_WAKE	I	HOST wake-up Bluetooth device
50	BT_HOST_WAKE	O	Bluetooth device to wake-up HOST

# 8. Dimensions

## 8.1 Physical Dimensions

(Unit: mm)

< TOP VIEW >

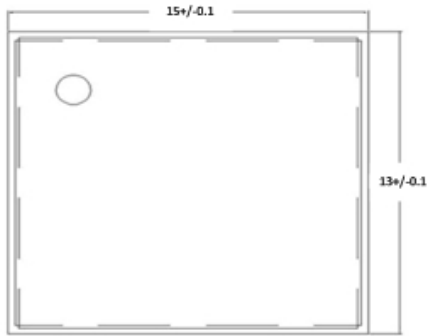

< Side View >



< TOP VIEW >

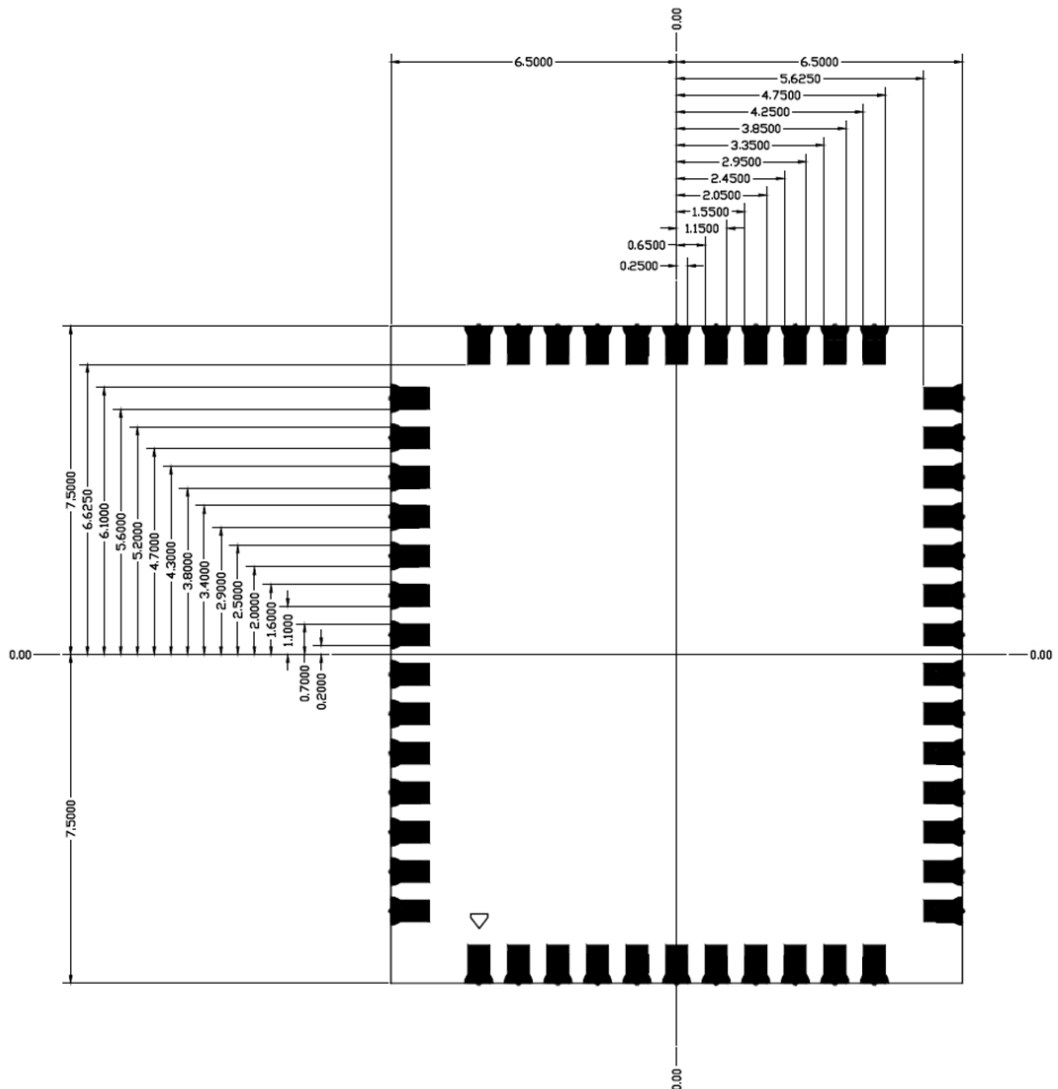

## 8.2 Layout Recommendation

(Unit: mm)

< TOP VIEW >

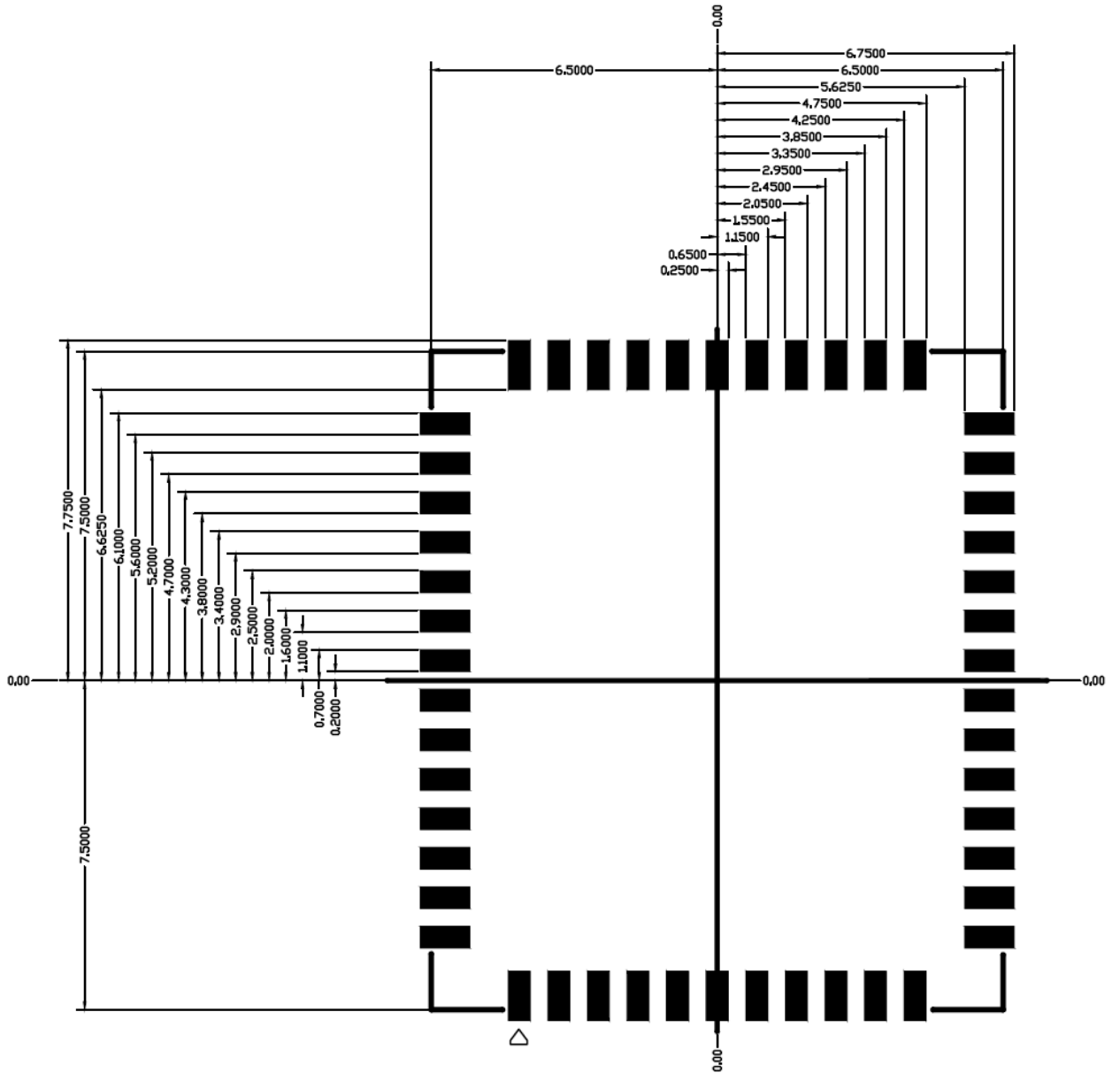

## 9. External clock reference

External LPO signal characteristics

Parameter	Specification	Units
Nominal input frequency	32.768	kHz
Frequency accuracy	±30	ppm
Duty cycle	30 - 70	%
Input signal amplitude	1600 to 3300	mV, p-p
Signal type	Square-wave or sine-wave	-
Input impedance	>100k	Ω
	<5	pF
Clock jitter (integrated over 300Hz – 15KHz)	<1	Hz
Output high voltage	0.7V <sub>io</sub> - V <sub>io</sub>	V

### 9.1 SDIO Pin Description

The module supports SDIO version 3.0 for all 1.8V 4-bit UHSI speeds: SDR50(100 Mbps),SDR104(208MHz) and DDR50(50MHz, dual rates) in addition to the 3.3V default speed(25MHz) and high speed (50 MHz). It has the ability to stop the SDIO clock and map the interrupt signal into a GPIO pin. This ‘out-of-band’ interrupt signal notifies the host when the WLAN device wants to turn on the SDIO interface. The ability to force the control of the gated clocks from within the WLAN chip is also provided.

- ❖ Function 0 Standard SDIO function (Max BlockSize / ByteCount = 32B)
- ❖ Function 1 Backplane Function to access the internal System On Chip (SOC) address space (Max BlockSize / ByteCount = 64B)
- ❖ Function 2 WLAN Function for efficient WLAN packet transfer through DMA (Max BlockSize/ByteCount=512B)

SDIO Pin Description

SD 4-Bit Mode	
DATA0	Data Line 0
DATA1	Data Line 1 or Interrupt
DATA2	Data Line 2 or Read Wait
DATA3	Data Line 3
CLK	Clock
CMD	Command Line

# 10. Host Interface Timing Diagram

## 10.1 Power-up Sequence Timing Diagram

The module has signals that allow the host to control power consumption by enabling or disabling the Bluetooth, WLAN and internal regulator blocks. These signals are described below.

Additionally, diagrams are provided to indicate proper sequencing of the signals for various operating states. The timing value indicated are minimum required values: longer delays are also acceptable.

- ※ WL\_REG\_ON: Used by the PMU to power up or power down the internal regulators used by the WLAN section. When this pin is high, the regulators are enabled and the WLAN section is out of reset. When this pin is low the WLAN section is in reset.
- ※ BT\_REG\_ON: Used by the PMU to power up or power down the internal regulators used by the BT section. Low asserting reset for Bluetooth. This pin has no effect on WLAN and does not control any PMU functions. This pin must be driven high or low (not left floating).

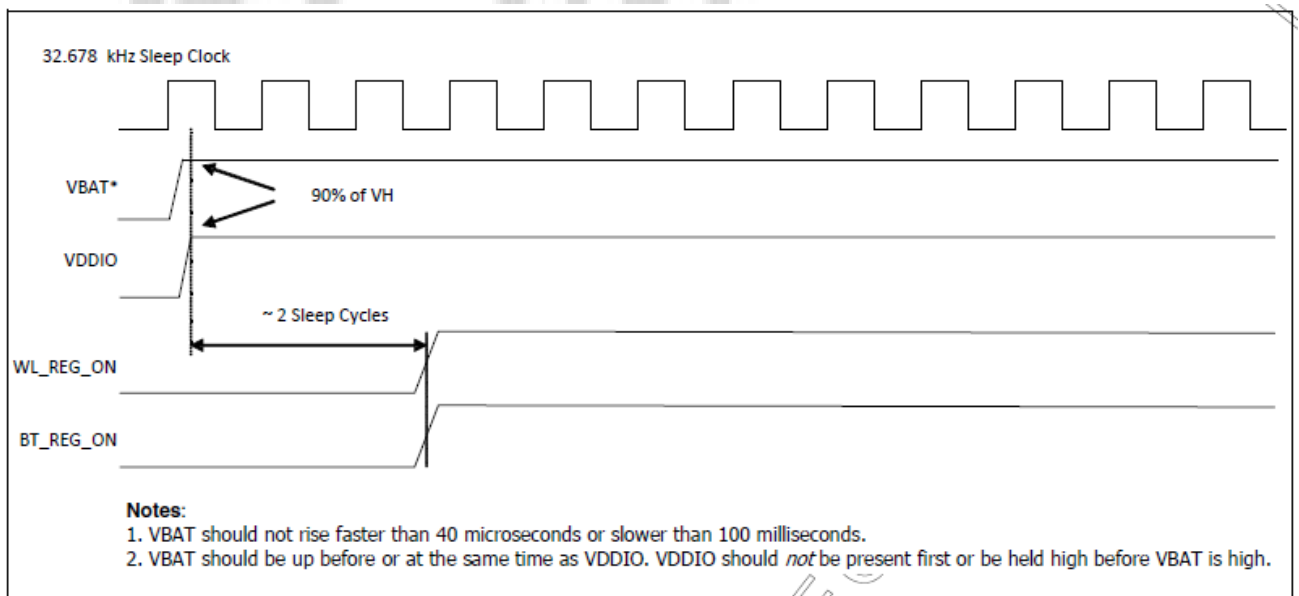

WLAN=ON, Bluetooth=ON

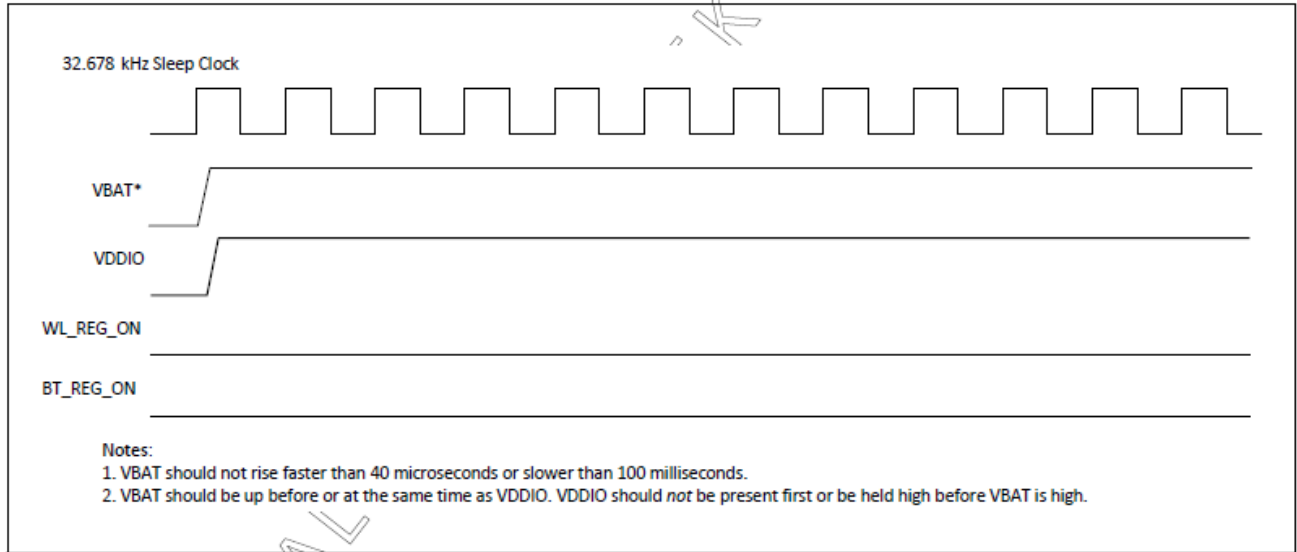

WLAN=OFF, Bluetooth=OFF

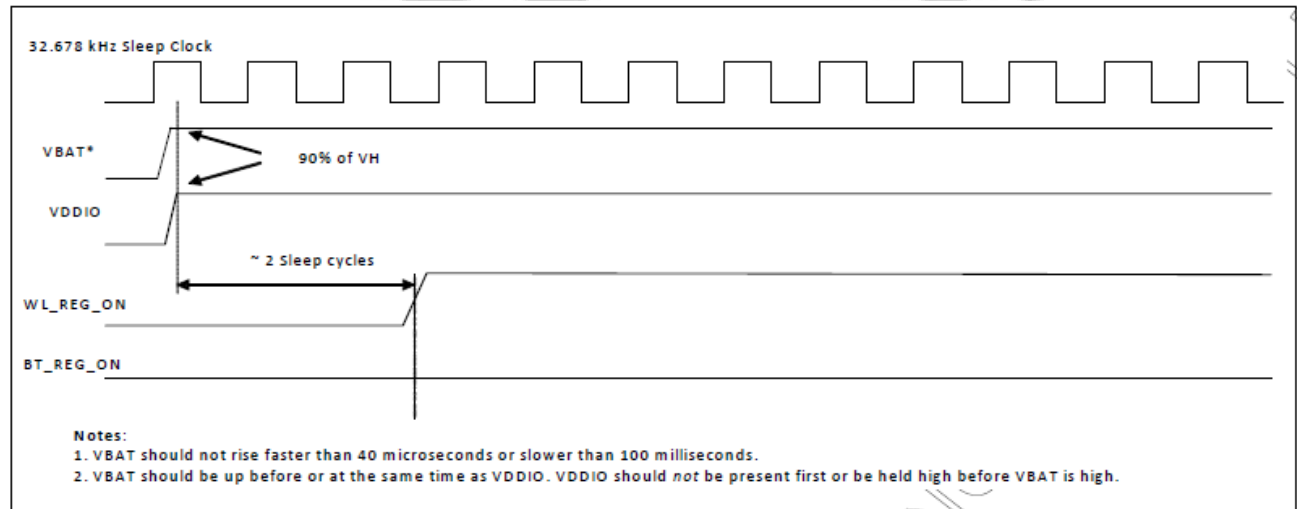

WLAN=ON, Bluetooth=OFF

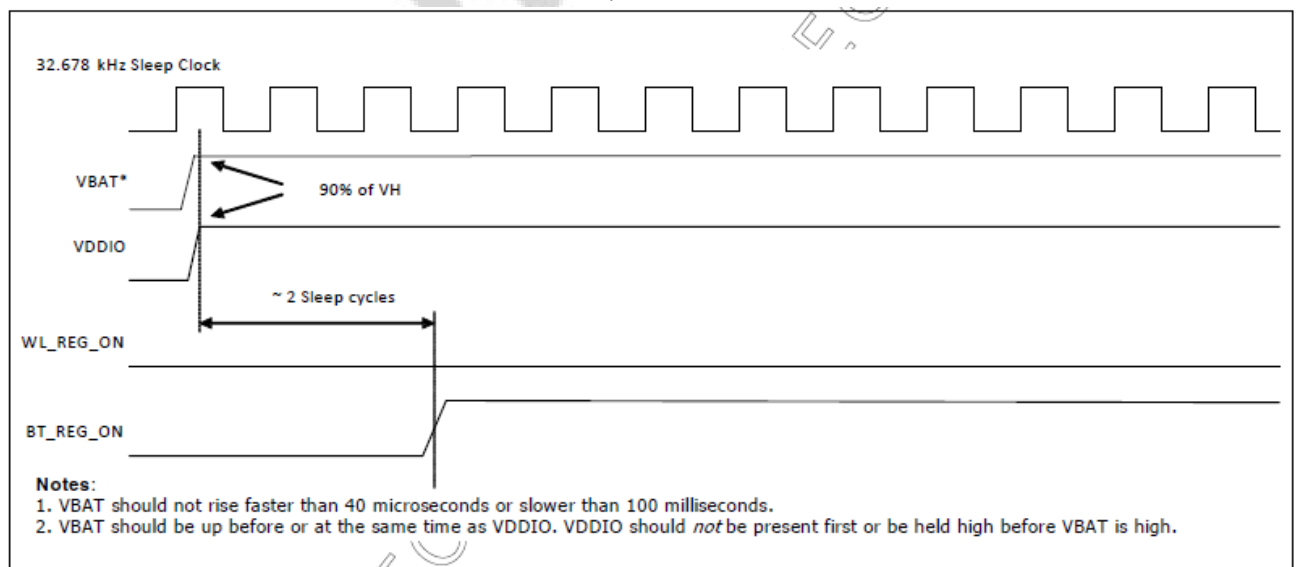

WLAN=OFF, Bluetooth=ON

## 10.2 SDIO Default Mode Timing Diagram

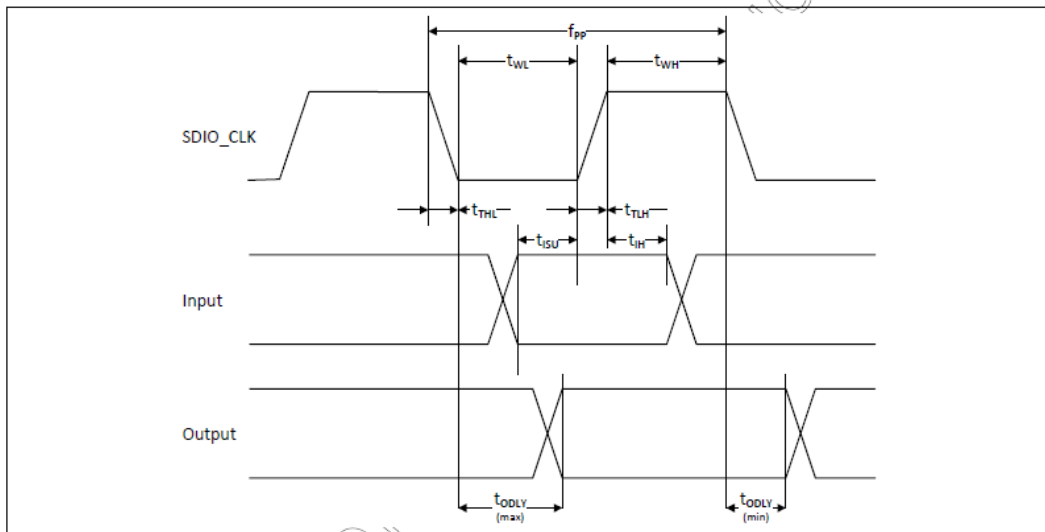

Parameter	Symbol	Minimum	Typical	Maximum	Unit
<b>SDIO CLK (All values are referred to minimum VIH and maximum VIL<sup>b</sup>)</b>					
Frequency – Data Transfer mode	f <sub>PP</sub>	0	–	25	MHz
Frequency – Identification mode	f <sub>OD</sub>	0	–	400	kHz
Clock low time	t <sub>WL</sub>	10	–	–	ns
Clock high time	t <sub>WH</sub>	10	–	–	ns
Clock rise time	t <sub>TLH</sub>	–	–	10	ns
Clock low time	t <sub>THL</sub>	–	–	10	ns
<b>Inputs: CMD, DAT (referenced to CLK)</b>					
Input setup time	t <sub>ISU</sub>	5	–	–	ns
Input hold time	t <sub>IH</sub>	5	–	–	ns
<b>Outputs: CMD, DAT (referenced to CLK)</b>					
Output delay time – Data Transfer mode	t <sub>ODLY</sub>	0	–	14	ns
Output delay time – Identification mode	t <sub>ODLY</sub>	0	–	50	ns

- a. Timing is based on  $CL \leq 40\text{pF}$  load on CMD and Data.  
 b.  $\min(V_{ih}) = 0.7 \times V_{DDIO}$  and  $\max(V_{il}) = 0.2 \times V_{DDIO}$ .

### 10.3 SDIO High Speed Mode Timing Diagram

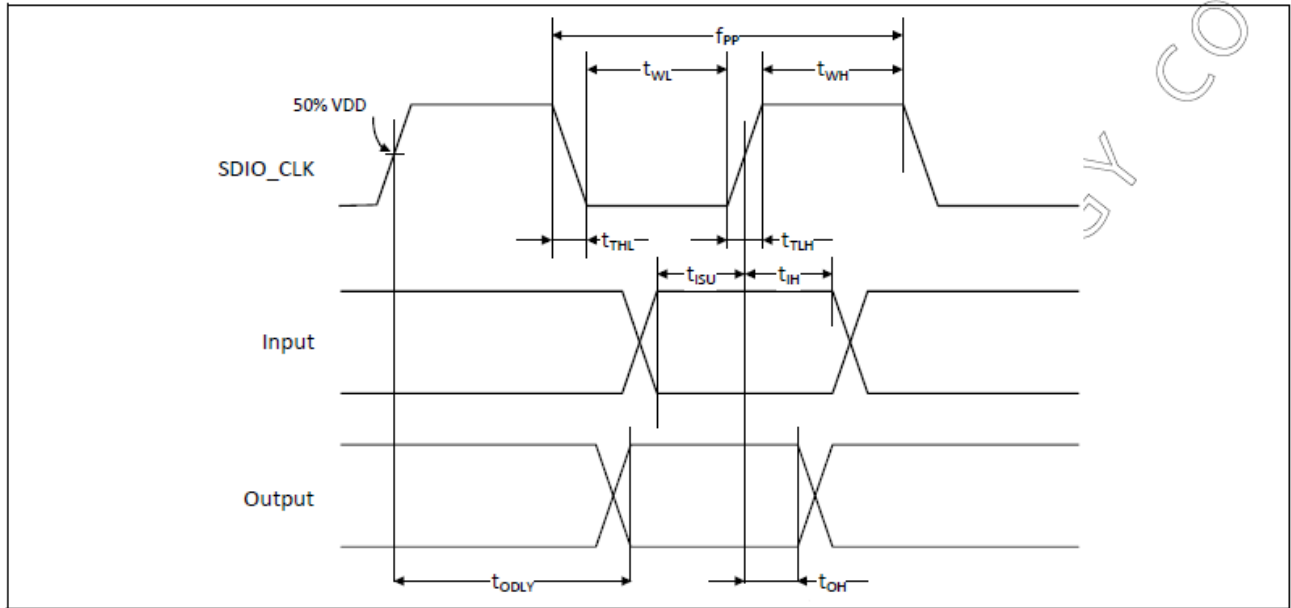

Parameter	Symbol	Minimum	Typical	Maximum	Unit
<b>SDIO CLK (all values are referred to minimum VIH and maximum VIL<sup>b</sup>)</b>					
Frequency – Data Transfer Mode	fPP	0	–	50	MHz
Frequency – Identification Mode	fOD	0	–	400	kHz
Clock low time	tWL	7	–	–	ns
Clock high time	tWH	7	–	–	ns
Clock rise time	tTLH	–	–	3	ns
Clock low time	tTHL	–	–	3	ns
<b>Inputs: CMD, DAT (referenced to CLK)</b>					
Input setup Time	tISU	6	–	–	ns
Input hold Time	tIH	2	–	–	ns
<b>Outputs: CMD, DAT (referenced to CLK)</b>					
Output delay time – Data Transfer Mode	tODLY	–	–	14	ns
Output hold time	tOH	2.5	–	–	ns
Total system capacitance (each line)	CL	–	–	40	pF

a. Timing is based on  $CL \leq 40$  pF load on CMD and Data.  
 b.  $\min(V_{ih}) = 0.7 \times V_{DDIO}$  and  $\max(V_{il}) = 0.2 \times V_{DDIO}$ .

### 10.4 SDIO Bus Timing Specifications in SDR Modes

#### Clock timing(SDR Modes)

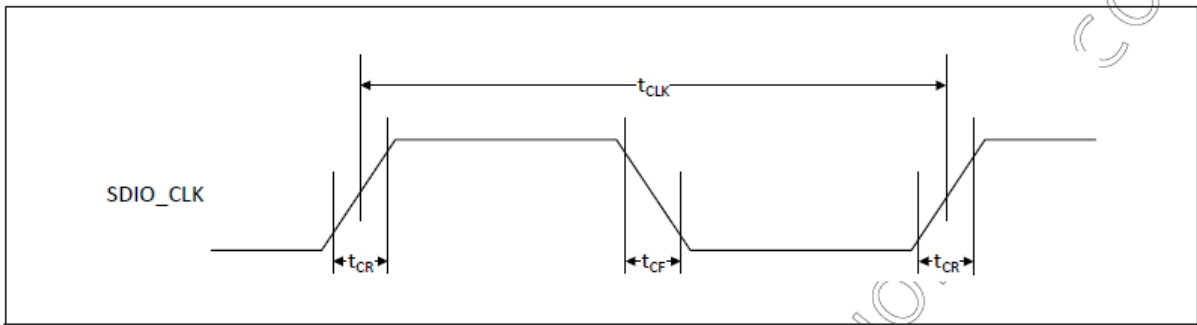

Parameter	Symbol	Minimum	Maximum	Unit	Comments
-	$t_{CLK}$	40	-	ns	SDR12 mode
		20	-	ns	SDR25 mode
		10	-	ns	SDR50 mode
		4.8	-	ns	SDR104 mode
-	$t_{CR}, t_{CF}$	-	$0.2 \times t_{CLK}$	ns	$t_{CR}, t_{CF} < 2.00$ ns (max) @100 MHz, $C_{CARD} = 10$ pF $t_{CR}, t_{CF} < 0.96$ ns (max) @208 MHz, $C_{CARD} = 10$ pF
Clock duty	-	30	70	%	-

#### Card Input timing (SDR Modes)

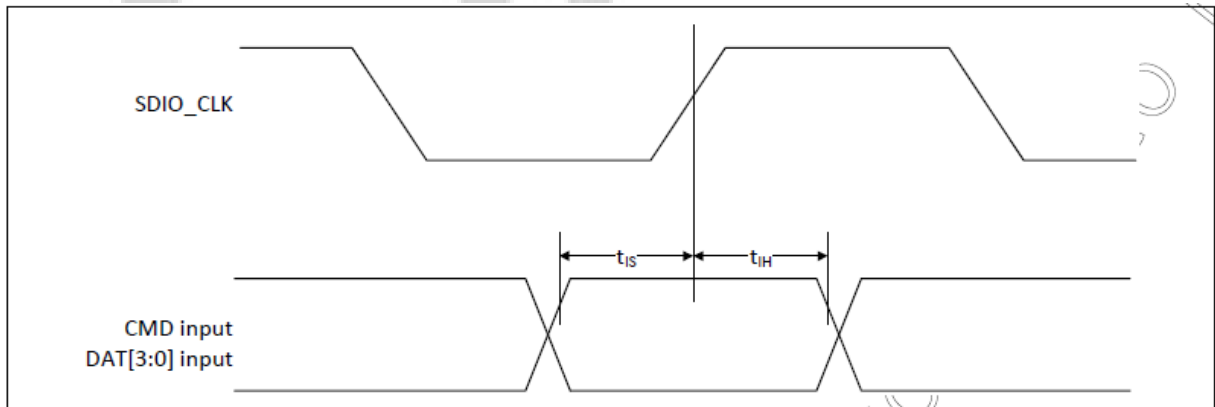

Symbol	Minimum	Maximum	Unit	Comments
<b>SDR104 Mode</b>				
$t_{IS}$	1.70 <sup>a</sup>	-	ns	$C_{CARD} = 10$ pF, VCT = 0.975V
$t_{IH}$	0.80	-	ns	$C_{CARD} = 5$ pF, VCT = 0.975V
<b>SDR50 Mode</b>				
$t_{IS}$	3.00	-	ns	$C_{CARD} = 10$ pF, VCT = 0.975V
$t_{IH}$	0.80	-	ns	$C_{CARD} = 5$ pF, VCT = 0.975V

a. SDIO 3.0 specification value is 1.40 ns.

Card output timing (SDR Modes up to 100MHz)

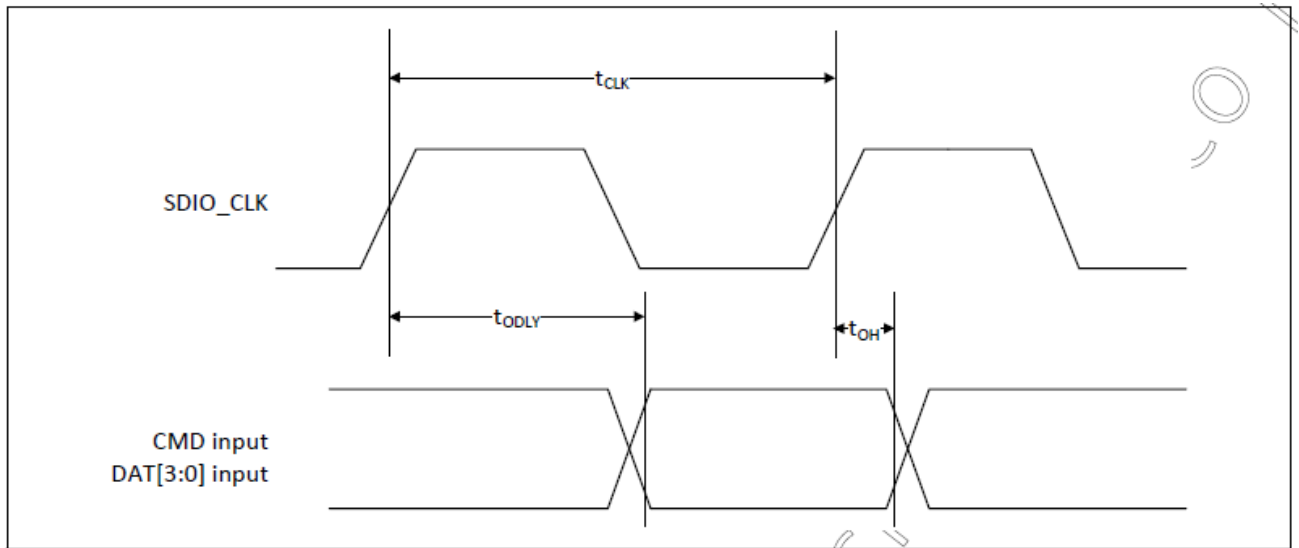

Symbol	Minimum	Maximum	Unit	Comments
$t_{ODLY}$	–	7.85 <sup>a</sup>	ns	$t_{CLK} \geq 10$ ns $C_L = 30$ pF using driver type B for SDR50
$t_{ODLY}$	–	14.0	ns	$t_{CLK} \geq 20$ ns $C_L = 40$ pF using for SDR12, SDR25
$t_{OH}$	1.5	–	ns	Hold time at the $t_{ODLY}$ (min) $C_L = 15$ pF

a. SDIO 3.0 specification value is 7.5 ns.

Card output timing (SDR Modes 100MHz to 208MHz)

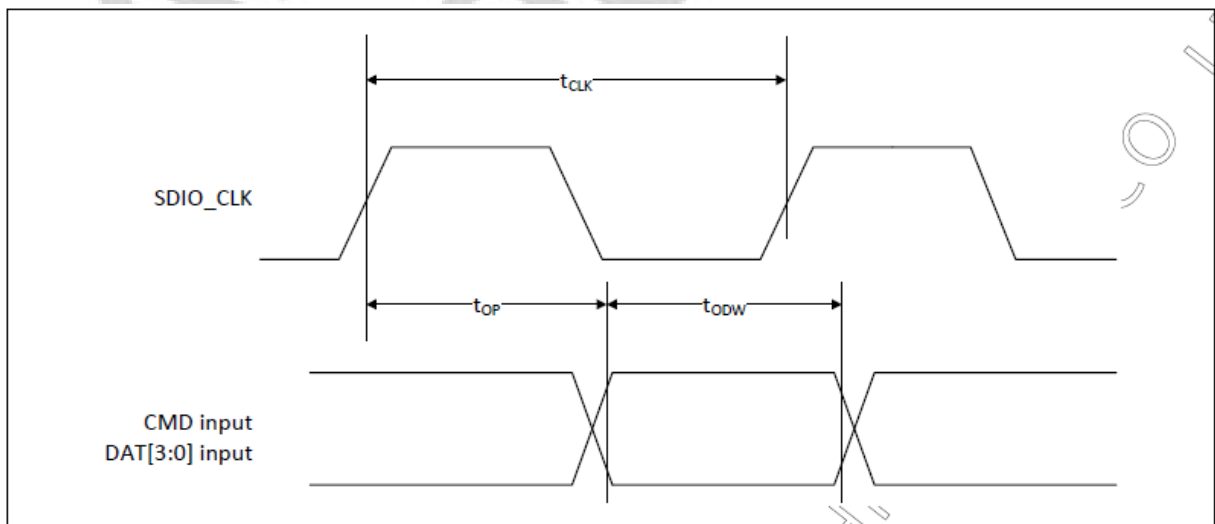

Symbol	Minimum	Maximum	Unit	Comments
$t_{OP}$	0	2	UI	Card output phase
$\Delta t_{OP}$	–350	+1550	ps	Delay variation due to temp change after tuning
$t_{ODW}$	0.60	–	UI	$t_{ODW} = 2.88$ ns @ 208 MHz

- $\Delta t_{OP} = +1550$  ps for junction temperature of  $\Delta t_{OP} = 90$  degrees during operation
- $\Delta t_{OP} = -350$  ps for junction temperature of  $\Delta t_{OP} = -20$  degrees during operation
- $\Delta t_{OP} = +2600$  ps for junction temperature of  $\Delta t_{OP} = -20$  to  $+125$  degrees during operation

### 10.5 SDIO Bus Timing Specifications in DDR50 Mode

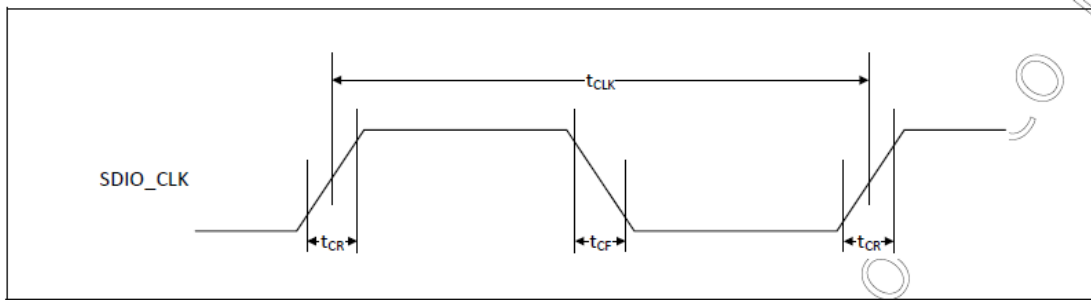

Parameter	Symbol	Minimum	Maximum	Unit	Comments
–	$t_{CLK}$	20	–	ns	DDR50 mode
–	$t_{CR}, t_{CF}$	–	$0.2 \times t_{CLK}$	ns	$t_{CR}, t_{CF} < 4.00$ ns (max) @50 MHz, $C_{CARD} = 10$ pF
Clock duty	–	45	55	%	–

### Data Timing

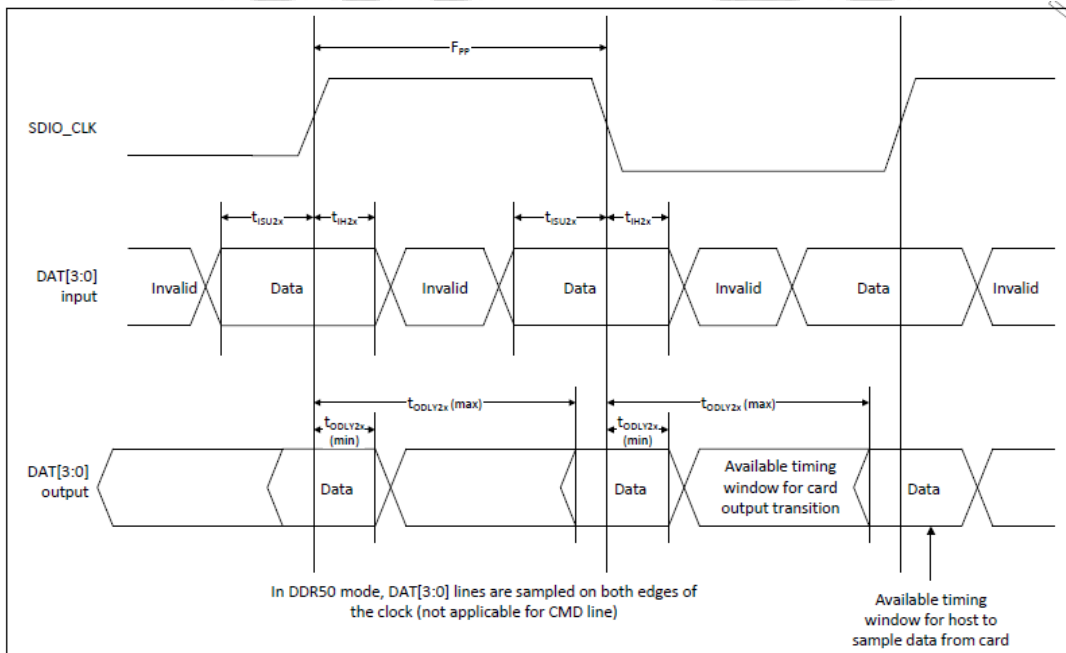

Parameter	Symbol	Minimum	Maximum	Unit	Comments
<b>Input CMD</b>					
Input setup time	$t_{ISU}$	6	–	ns	$C_{CARD} < 10$ pF (1 Card)
Input hold time	$t_{IH}$	0.8	–	ns	$C_{CARD} < 10$ pF (1 Card)
<b>Output CMD</b>					
Output delay time	$t_{ODLY}$	–	13.7	ns	$C_{CARD} < 30$ pF (1 Card)
Output hold time	$t_{OH}$	1.5	–	ns	$C_{CARD} < 15$ pF (1 Card)
<b>Input DAT</b>					
Input setup time	$t_{ISU2x}$	3	–	ns	$C_{CARD} < 10$ pF (1 Card)
Input hold time	$t_{IH2x}$	0.8	–	ns	$C_{CARD} < 10$ pF (1 Card)
<b>Output DAT</b>					
Output delay time	$t_{ODLY2x}$	–	7.85 <sup>a</sup>	ns	$C_{CARD} < 25$ pF (1 Card)
Output hold time	$t_{ODLY2x}$	1.5	–	ns	$C_{CARD} < 15$ pF (1 Card)

<sup>a</sup> SDIO 3.0 specification value is 7.0 ns.

# 11. Recommended Reflow Profile

Referred to IPC/JEDEC standard.

Peak Temperature : <math><250^{\circ}\text{C}</math>

Number of Times :  $\leq 2$  times

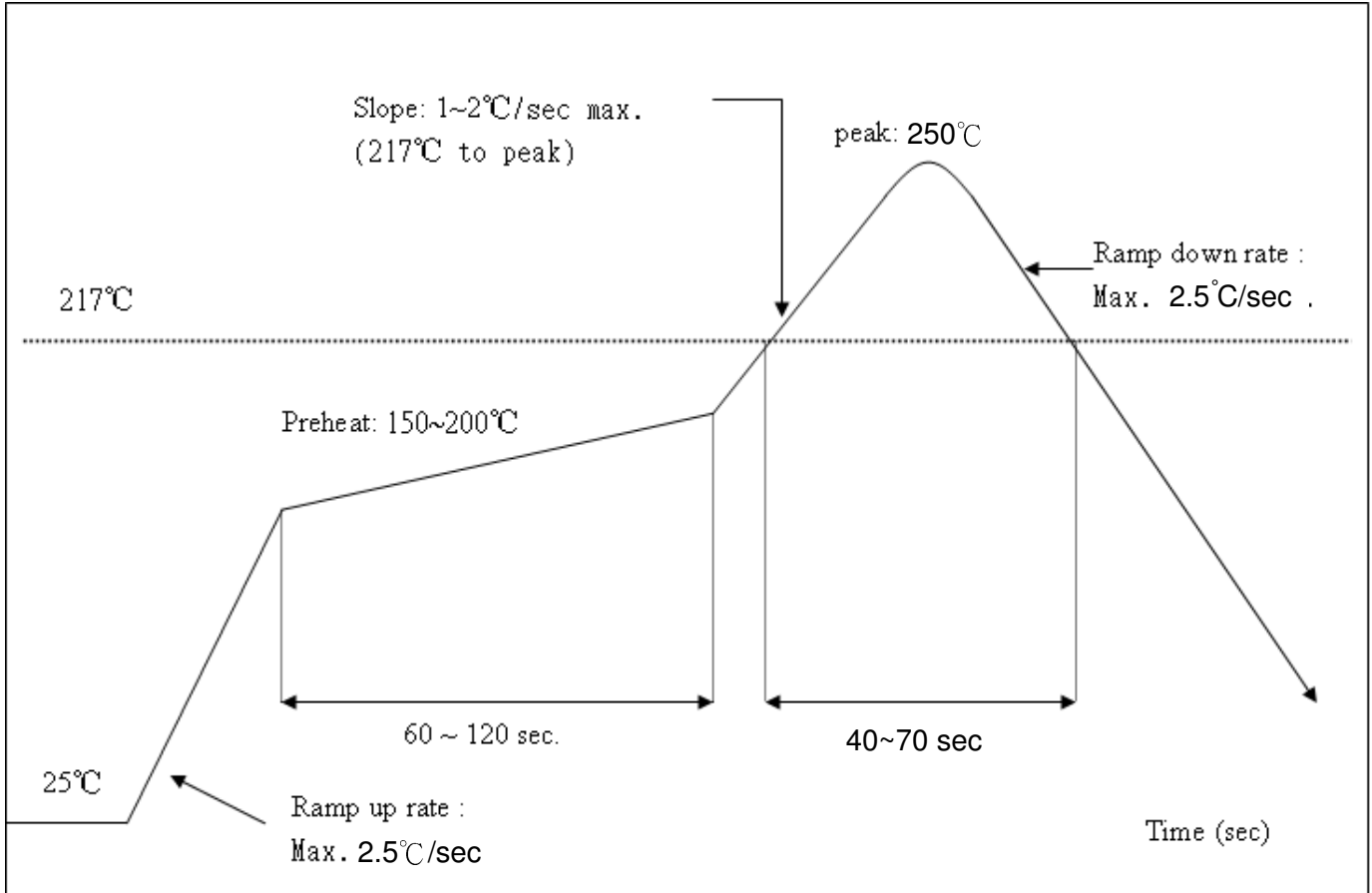

# 12. Package Information

## 12.1 Label

Label A → Anti-static and humidity notice

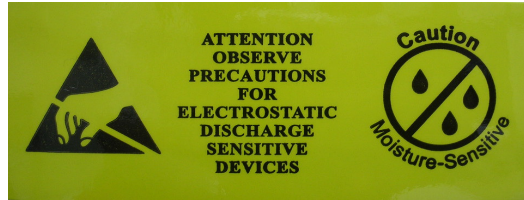





Label B → MSL caution / Storage Condition

	<b>Caution</b> This bag contains <b>MOISTURE-SENSITIVE DEVICES</b>	LEVEL <input type="text"/>
	If blank, see adjacent bar code label	
<ol style="list-style-type: none"> <li>Calculated shelf life in sealed bag: 12 months at &lt;40°C and &lt;90% relative humidity (RH)</li> <li>Peak package body temperature: _____ °C  <small>If blank, see adjacent bar code label</small></li> <li>After bag is opened, devices that will be subjected to reflow solder or other high temperature process must be           <ol style="list-style-type: none"> <li>Mounted within: _____ hours of factory conditions  <small>If blank, see adjacent bar code label</small>                ≤30°C/60% RH, or</li> <li>Stored per J-STD-033</li> </ol> </li> <li>Devices require bake, before mounting, if:           <ol style="list-style-type: none"> <li>Humidity Indicator Card reads &gt;10% for level 2a - 5a devices or &gt;60% for level 2 devices when read at 23 ± 5°C</li> <li>3a or 3b are not met</li> </ol> </li> <li>If baking is required, refer to IPC/JEDEC J-STD-033 for bake procedure</li> </ol>		
Bag Seal Date: _____ <small>If blank, see adjacent bar code label</small>		
Note: Level and body temperature defined by IPC/JEDEC J-STD-020		

Label C → Inner box label .

<b>PKG S/N :</b>	 9PKG12013100001
<b>Model:</b>	 XXXXXXXXXXXX
<b>P/N :</b>	 99P-W01-0048R
<b>Qty :</b>	 1500
<b>Date Code :</b>	 1205
<b>Lot Code :</b>	 T0C102B

Label D → Carton box label .

<b>AMPAK Technology</b>	
<b>Model Name :</b>	 XXXXXXXXXXXX
<b>Part No :</b>	 99P-W01-0048R
<b>Quantity :</b>	 7500 ea
<b>Lot DIC :</b>	 20081000033
<b>Manufacture :</b>	 2012/02/22

## 12.2 Dimension

1. 10 sprocket hole pitch cumulative tolerance  $\pm 0.20$ .
2. Carrier camber is within 1 mm in 250 mm.
3. Material : Black Conductive Polystyrene Alloy.
4. All dimensions meet EIA-481-D requirements.
5. Thickness :  $0.30 \pm 0.05$ mm.
6. Packing length per 22" reel : 98.5 Meters.(1:3)
7. Component load per 13" reel : 1500 pcs.

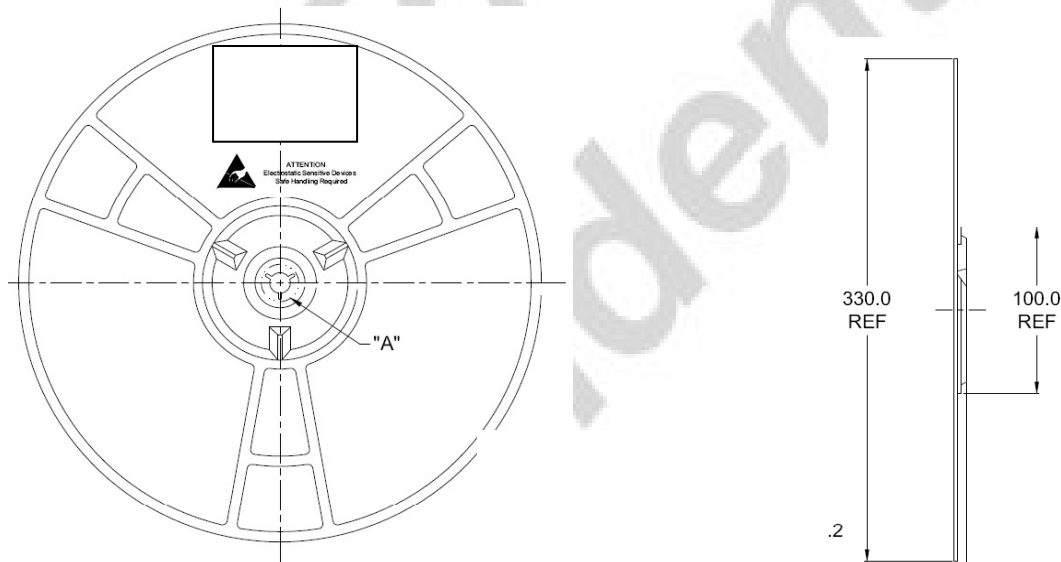

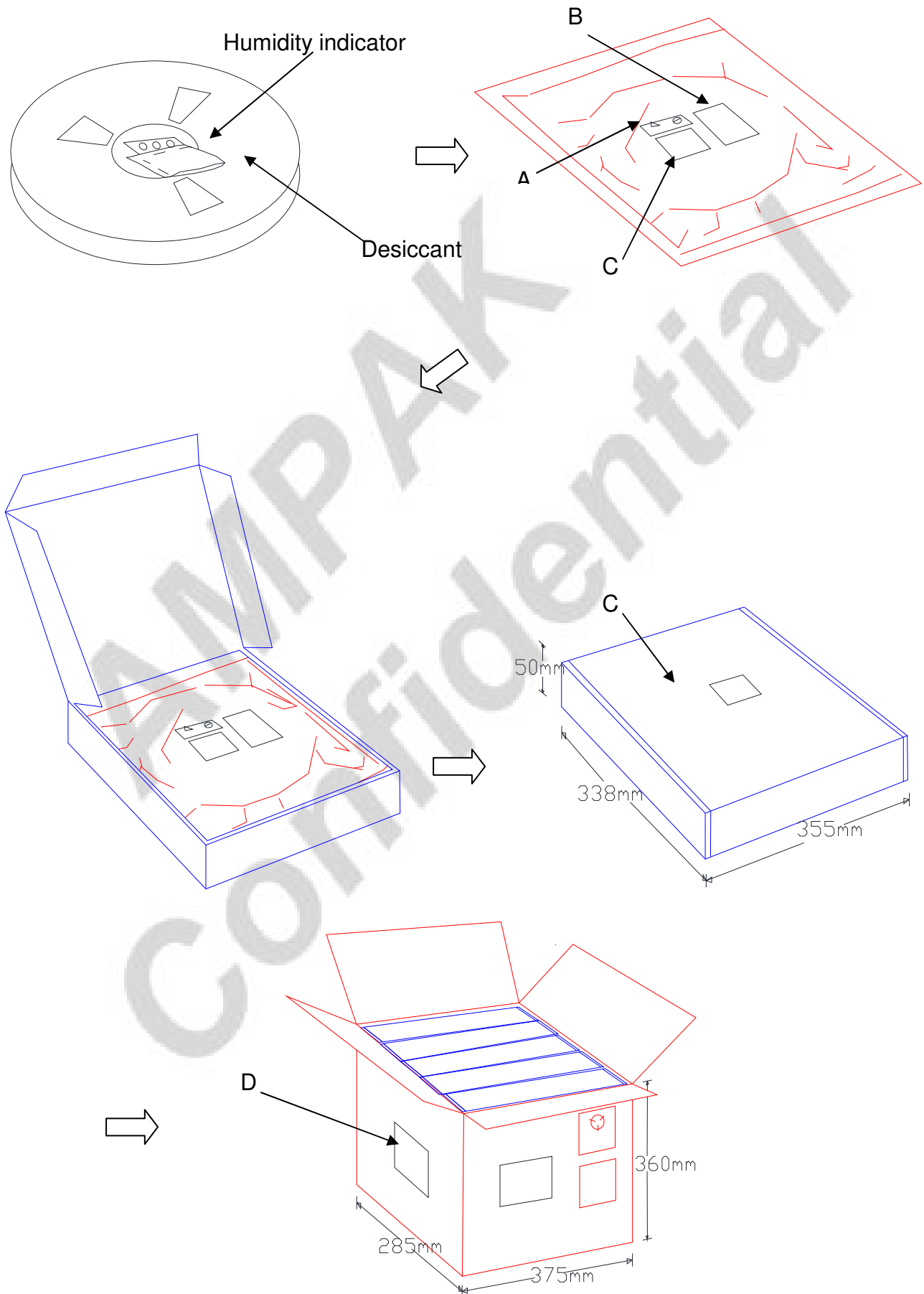

### 12.3 MSL Level / Storage Condition

	<p><b>Caution</b> This bag contains <b>MOISTURE-SENSITIVE DEVICES</b></p> <p>Do not open except under controlled conditions</p> <p>1. Calculated shelf life in sealed bag: 12 months at &lt; 40°C and &lt; 90% relative humidity(RH)</p> <p>2. Peak package body temperature:      225°C   240°C   250°C   260°C  <input type="checkbox"/>        <input type="checkbox"/>        <input checked="" type="checkbox"/>        <input type="checkbox"/></p> <p>3. After bag is opened, devices that will be subjected to reflow solder or other high temperature process must  a) Mounted within: 48 hours of factory conditions  &lt;30°C/60% RH, OR  b) Stored at &lt;10% RH</p> <p>4. Devices require bake, before mounting, if:  a) Humidity Indicator Card is &gt;10% when read at 23±5°C  b) 3a or 3b not met</p> <p>5. If baking is required, devices may be baked for 24 hours at 125±5°C</p> <p>Note : If device containers cannot be subjected to high temperature or shorter bake times are desired, reference IPC/JEDEC J-STD-033 for bake procedure</p> <p>Bag Seal Date:      <b>See-SEAL DATE LABEL</b></p> <p>Note: Level and body temperature defined by IPC/JEDEC J-STD-020</p>	<p>LEVEL</p> <div style="border: 1px solid black; padding: 10px; width: 60px; margin: 0 auto;"> <p style="font-size: 2em; margin: 0;">4</p> </div>
---	---	--

**※NOTE : Accumulated baking time should not exceed 96hrs**